

# **LECTURE NOTES**

**ON**

# **PRESTRESSED CONCRETE STRUCTURES**

**Course code: A80150**

**Regulation: R15 (JNTUH)**

**IV B. Tech II Sem**

**PREPARED BY**

**Dr. VENU M**

**Professor**

**Mr GUDE RAMA KRISHNA**

**Assistant Professor**



**CIVIL ENGINEERING**

**INSTITUTE OF AERONAUTICAL ENGINEERING**

**(Autonomous)**

**Dundigal, Hyderabad - 500 043**

## UNIT-1

### INTRODUCTION

#### **Definition of Prestress:**

Prestress is defined as a method of applying pre-compression to control the stresses resulting due to external loads below the neutral axis of the beam tension developed due to external load which is more than the permissible limits of the plain concrete. The pre-compression applied (may be axial or eccentric) will induce the compressive stress below the neutral axis or as a whole of the beam c/s. Resulting either no tension or compression.

#### **Basic Concept**

Prestressed concrete is basically concrete in which internal stresses of a suitable magnitude and distribution are introduced so that the stresses resulting from the external loads are counteracted to a desired degree.

#### **Terminology**

- 1. Tendon:** A stretched element used in a concrete member of structure to impart prestress to the concrete.



Figure: Tendons

- 2. Anchorage:** A device generally used to enable the tendon to impart and maintain prestress in concrete.



Figure: Anchorage

- 3. Pretensioning:** A method of prestressing concrete in which the tendons are tensioned before the concrete is placed. In this method, the concrete is introduced by bond between steel & concrete.
- 4. Post-tensioning:** A method of prestressing concrete by tensioning the tendons against hardened concrete. In this method, the prestress is imparted to concrete by bearing.

#### **Materials for prestress concrete members:**

##### **1. Cement:**

The cement used should be any of the following

- (a) Ordinary Portland cement conforming to IS269
- (b) Portland slag cement conforming to IS455. But the slag content should not be more than 50%.
- (c) Rapid hardening Portland cement conforming to IS8041.

(d) High strength ordinary Portland cement conforming to IS8112.

## 2. Concrete:

Prestress concrete requires concrete, which has a high compressive strength reasonably early age with comparatively higher tensile strength than ordinary concrete. The concrete for the members shall be air-entrained concrete composed of Portland cement, fine and coarse aggregates, admixtures and water. The air-entraining feature may be obtained by the use of either air-entraining Portland cement or an approved air-entraining admixture. The entrained air content shall be not less than 4 percent or more than 6 percent.

Minimum cement content of 300 to 360 kg/m<sup>3</sup> is prescribed for the durability requirement.

The water content should be as low as possible.

## 3. Steel

High tensile steel , tendons , strands or cables

The steel used in prestress shall be any one of the following:-

- (a) Plain hard-drawn steel wire conforming to IS1785 (Part-I & Part-III)
- (b) Cold drawn indented wire conforming to IS6003
- (c) High tensile steel wire bar conforming to IS2090
- (d) Uncoated stress relived strand conforming to IS6006

### High strength steel contains:

0.7 to 0.8% carbons,

0.6% manganese,

0.1% silica

## **Durability, Fire Resistance & Cover Requirements For P.S.C Members:-**

According to IS: 1343-1980

20 mm cover for pretensioned members

30 mm or size of the cable whichever is bigger for post tensioned members.

If the prestress members are exposed to an aggressive environment, these covers are increased by another 10 mm.

### **Necessity of high grade of concrete & steel:**

Higher the grade of concrete higher the bond strength which is vital in pretensioned concrete, Also higher bearing strength which is vital in post-tensioned concrete. Further creep & shrinkage losses are minimum with high-grade concrete.

Generally minimum M30 grade concrete is used for post-tensioned & M40 grade concrete is used for pretensioned members.

The losses in prestress members due to various reasons are generally in the range of 250 N/mm<sup>2</sup> to 400 N/mm<sup>2</sup>. If mild steel or deformed steel is used the residual stresses after losses is either zero or negligible. Hence high tensile steel wires are used which varies from 1600 to 2000 N/mm<sup>2</sup>.

### **History and development of prestress of PSC:**

A prestressed concrete structure is different from a conventional reinforced concrete structure due to the application of an **initial load on the structure prior to its use**. The initial load or 'prestress' is applied to enable the structure to counteract the stresses arising during its service period.

The prestressing of a structure is not the only instance of prestressing. The concept of prestressing existed before the applications in concrete. Two examples of prestressing before the development of prestressed concrete are provided.

### **Force-fitting of metal bands on wooden barrels:**

The metal bands induce a state of initial hoop compression, to counteract the hoop tension caused by filling of liquid in the barrels.

The prestressing of a structure is not the only instance of prestressing. The concept of prestressing existed before the applications in concrete. Two examples of prestressing before the development of prestressed concrete are provided

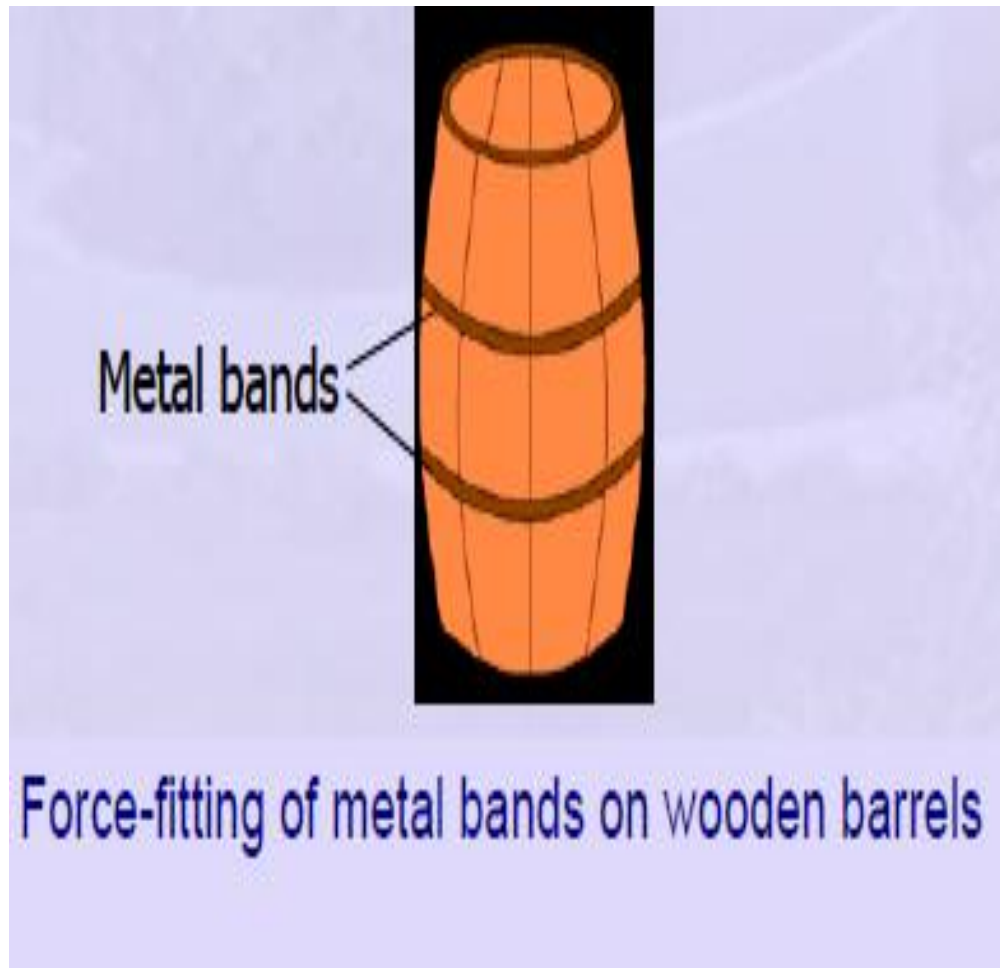

**Figure: force fitting of metal bands on wooden barrels**

### **Pre-tensioning the spokes in a bicycle wheel**

The pre-tension of a spoke in a bicycle wheel is applied to such an extent that there will always be a residual tension in the spoke.

That tension in spoke will nullify the applied compression.

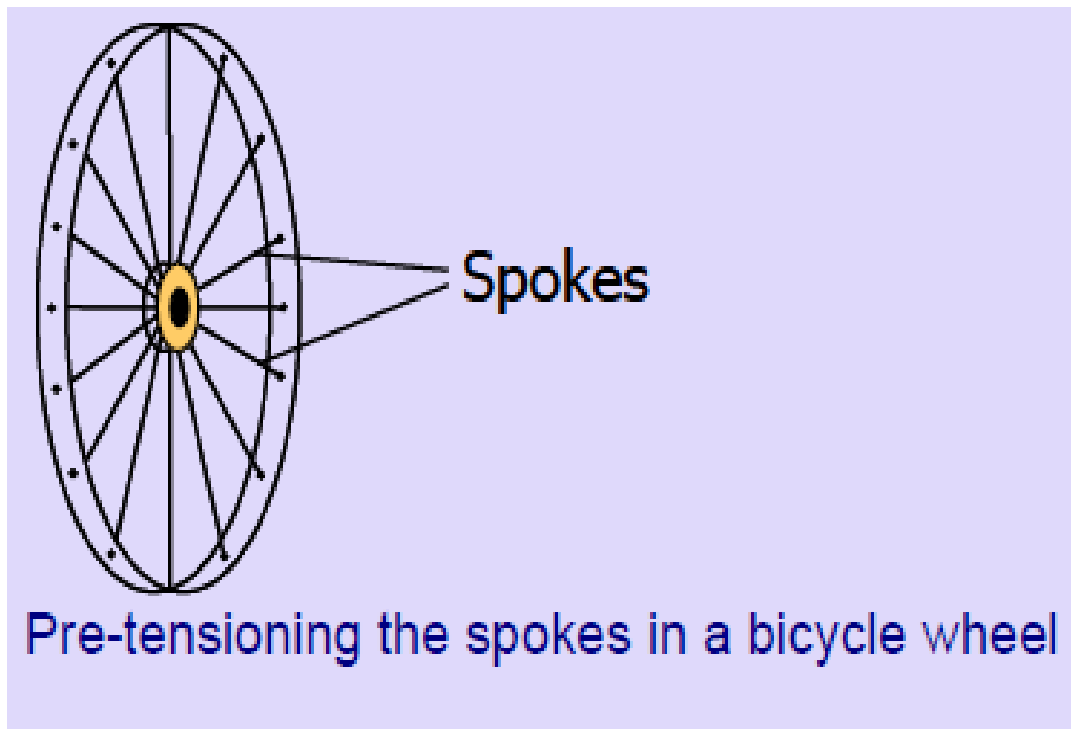

Figure: pre tensioning the spokes in a bicycle wheel

For concrete, internal stresses are induced (usually, by means of tensioned steel) for the following reasons.

- The tensile strength of concrete is only about 8% to 14% of its compressive strength.
- Cracks tend to develop at early stages of loading in flexural members such as beams and slabs.
- To prevent such cracks, compressive force can be suitably applied in the perpendicular direction.
- Prestressing enhances the bending, shear and torsional capacities of the flexural members.
- In pipes and liquid storage tanks, the hoop tensile stresses can be effectively counteracted by circular prestressing.

#### **Forms of Prestressing Steel :**

**Wires:** Prestressing wire is a single unit made of steel.

**Strands:** Two, three or seven wires are wound to form a prestressing strand.



Figure: strands

**Tendon:** A group of strands or wires are wound to form a prestressing tendon.

**Cable:** A group of tendons form a prestressing cable.

**Bars:** A tendon can be made up of a single steel bar. The diameter of a bar is much larger than that of a wire.

### **Nature of Concrete-Steel Interface**

#### **Bonded tendon:**

When there is adequate bond between the prestressing tendon and concrete, it is called a bonded tendon. Pre-tensioned and grouted post-tensioned tendons are bonded tendons.

#### **Unbonded tendon:**

When there is no bond between the prestressing tendon and concrete, it is called unbonded tendon. When grout is not applied after post-tensioning, the tendon is an unbonded tendon.

### **Stages of Loading**

The analysis of prestressed members can be different for the different stages of loading. The stages of loading are as follows.

1) Initial: It can be subdivided into two stages.

a) During tensioning of steel



- b) At transfer of prestress to concrete.
- 2) Intermediate: This includes the loads during transportation of the prestressed members.
- 3) Final: It can be subdivided into two stages.
  - a) At service, during operation.
  - b) At ultimate, during extreme events.

### **Advantages of Prestressing**

The prestressing of concrete has several advantages as compared to traditional reinforced concrete (RC) without prestressing. A fully prestressed concrete member is usually subjected to compression during service life. This rectifies several deficiencies of concrete.

The following text broadly mentions the advantages of a prestressed concrete member with an equivalent RC member. For each effect, the benefits are listed.

#### **1) Section remains uncracked under service loads**

Reduction of steel corrosion

- Increase in durability.

Full section is utilised

- Higher moment of inertia (higher stiffness)
- Less deformations (improved serviceability).

Increase in shear capacity.

Suitable for use in pressure vessels, liquid retaining structures.

Improved performance (resilience) under dynamic and fatigue loading.

#### **2) High span-to-depth ratios**

Larger spans possible with prestressing (bridges, buildings with large column-free spaces)

Typical values of span-to-depth ratios in slabs are given below.

Non-prestressed slab	28:1
Prestressed slab	45:1

For the same span, less depth compared to RC member.

- Reduction in self weight
- More aesthetic appeal due to slender sections
- More economical sections.

### 3) Suitable for precast construction

The advantages of precast construction are as follows.

- Rapid construction
- Better quality control
- Reduced maintenance
- Suitable for repetitive construction
- Multiple use of formwork
  - ⇒ Reduction of formwork
- Availability of standard shapes.

The following figure shows the common types of precast sections.

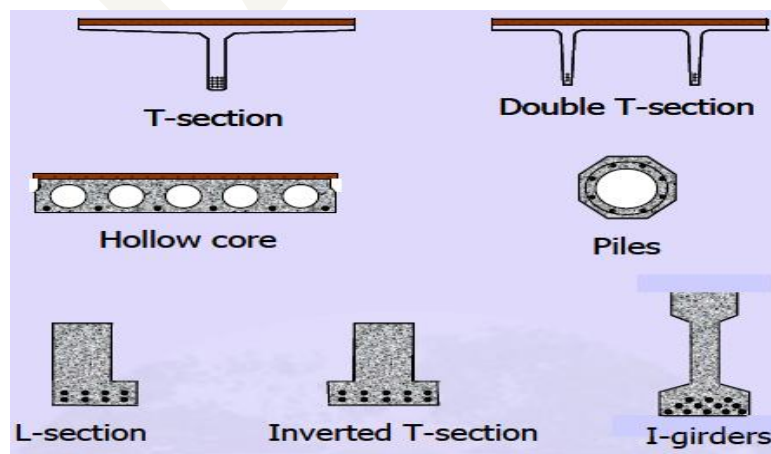

Figure: precast sections

- 4) The cross-section is utilized more efficiently in pre-stressed concrete as compared to reinforced concrete.
- 5) Pre stressed concrete allows for a longer span.
- 6) Pre-stressed concrete members offer more resistance against shear force.
- 7) Considering same depth of concrete member, a pre stressed concrete member is stiffer than the reinforced concrete member under working loads.
- 8) The use of higher strength concrete and high strength steel results in smaller cross-section.

### **Limitations of Prestressing:**

Although prestressing has advantages, some aspects need to be carefully addressed.

- Prestressing needs skilled technology. Hence, it is not as common as reinforced concrete.
- The use of high strength materials is costly.
- There is additional cost in auxiliary equipments.
- There is need for quality control and inspection.
- Prestressed concrete sections are less fire resistant.

### **Types of Prestressing**

Prestressing of concrete can be classified in several ways. The following classifications are discussed.

#### **Source of prestressing force**

This classification is based on the method by which the prestressing force is generated. There are four sources of prestressing force: Mechanical, hydraulic, electrical and chemical.

#### **External or internal prestressing**

This classification is based on the location of the prestressing tendon with respect to the concrete section.

### **Pre-tensioning or post-tensioning**

This is the most important classification and is based on the sequence of casting the concrete and applying tension to the tendons.

### **Linear or circular prestressing**

This classification is based on the shape of the member prestressed.

### **Full, limited or partial prestressing**

Based on the amount of prestressing force, three types of prestressing are defined.

### **Uniaxial, biaxial or multi-axial prestressing**

As the names suggest, the classification is based on the directions of prestressing a member.

### **Source of Prestressing Force:**

#### **Hydraulic Prestressing**

This is the simplest type of prestressing, producing large prestressing forces. The hydraulic jack used for the tensioning of tendons, comprises of calibrated pressure gauges which directly indicate the magnitude of force developed during the tensioning.

#### **Mechanical Prestressing**

In this type of prestressing, the devices includes weights with or without lever transmission, geared transmission in conjunction with pulley blocks, screw jacks with or without gear drives and wire-winding machines. This type of prestressing is adopted for mass scale production.

## **Electrical Prestressing**

In this type of prestressing, the steel wires are electrically heated and anchored before placing concrete in the moulds. This type of prestressing is also known as thermo-electric prestressing.

## **External or Internal Prestressing:**

### **External Prestressing:**

When the prestressing is achieved by elements located outside the concrete, it is called external prestressing. The tendons can lie outside the member (for example in I-girders or walls) or inside the hollow space of a box girder. This technique is adopted in bridges and strengthening of buildings. In the following figure, the box girder of a bridge is prestressed with tendons that lie outside the concrete.



Figure: External prestressing in circular tanks

### **Internal Prestressing:**

When the prestressing is achieved by elements located inside the concrete member (commonly, by embedded tendons), it is called internal prestressing. Most of the applications of prestressing are internal prestressing. In the following figure, concrete will be cast around the ducts for placing the tendons.

### **Pre-tensioning or Post-tensioning:**

#### **Pre-tensioning:**

Pre-tensioning is accomplished by stressing wires or strands, called tendons, to a predetermined amount by stretching them between two anchorages prior to placing concrete as shown in fig.1. The concrete is then placed and tendons become bonded to concrete throughout their length. After concrete has hardened, the tendons are released by cutting them at the anchorages. The tendons tend to regain their original length by shortening and in this process transfer through bond a compressive stress to the concrete. The tendons are usually stressed by the use of hydraulic jacks. The stress in tendons is maintained during the placing and curing of concrete by anchoring the ends of the tendons to abutments that may be as much as 200m apart. The abutments and other formwork used in this procedure are called prestressing bench or bed.



Figure: Pre tensioning of a member



### Post-tensioning:

The tension is applied to the tendons (located in a duct) after hardening of the concrete. The pre-compression is transmitted from steel to concrete by the anchorage device (at the end blocks).

The alternative to pre-tensioning is post-tensioning. In a post-tensioned beam, the tendons are stressed and each end is anchored to the concrete section after the concrete has been cast and has attained sufficient strength to safely withstand the prestressing force as shown in fig.2. in post-tensioning method, tendons are coated with grease or a bituminous material to prevent them from becoming bonded to concrete. Another method used in preventing the tendons from bonding to the concrete during placing and curing of concrete is to encase the tendon in a flexible metal hose before placing it in the forms. The metal hose is referred to as sheath or duct and remains in the structure.

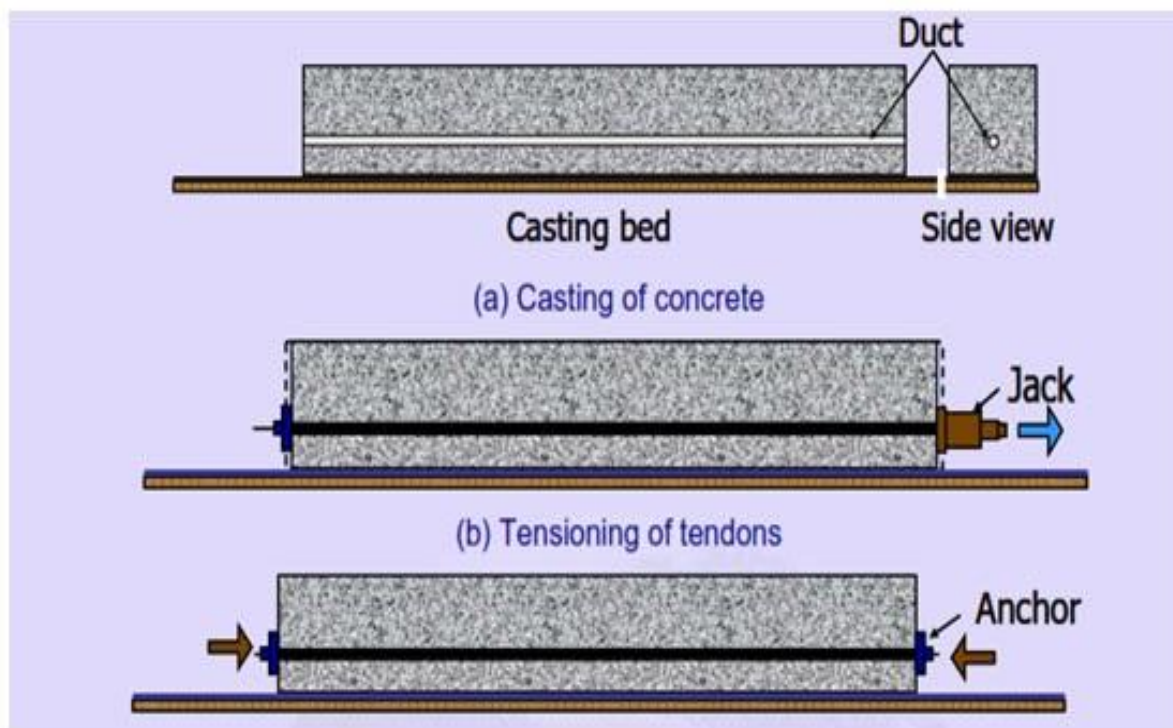

Figure: Post tensioning

## **Linear or Circular Prestressing:**

### **Linear Prestressing:**

When the prestressed members are straight or flat, in the direction of prestressing, the prestressing is called linear prestressing. For example, prestressing of beams, piles, poles and slabs. The profile of the prestressing tendon may be curved. The following figure shows linearly prestressed railway sleepers.



Figure: railway sleepers

### **Circular Prestressing:**

When the prestressed members are curved, in the direction of prestressing, the prestressing is called circular prestressing. For example, circumferential prestressing of tanks, silos, pipes and similar structures. The following figure shows the containment structure for a nuclear reactor which is circularly prestressed.





Figure: pre stressing of circular tank

### **Full, Limited or Partial Prestressing:**

#### **Full Prestressing**

When the level of prestressing is such that no tensile stress is allowed in concrete under service loads, it is called Full Prestressing (Type 1, as per **IS:1343 - 1980**).

#### **Limited Prestressing**

When the level of prestressing is such that the tensile stress under service loads is within the cracking stress of concrete, it is called Limited Prestressing (Type 2).

#### **Partial Prestressing**

When the level of prestressing is such that under tensile stresses due to service loads, the crack width is within the allowable limit, it is called Partial Prestressing (Type 3).

## **Uniaxial, Biaxial or Multiaxial Prestressing:**

### **Uniaxial Prestressing:**

When the prestressing tendons are parallel to one axis, it is called Uniaxial Prestressing. For example, longitudinal prestressing of beams.

### **Biaxial Prestressing:**

When there are prestressing tendons parallel to two axes, it is called Biaxial Prestressing.

### **Multiaxial Prestressing**

When the prestressing tendons are parallel to more than two axes, it is called Multiaxial Prestressing. For example, prestressing of domes.

### **Differences of Prestressed Concrete Over Reinforced Concrete:**

1. In prestress concrete member steel plays active role. The stress in steel prevails whether external load is there or not. But in R.C.C., steel plays a passive role. The stress in steel in R.C.C members depends upon the external loads. *i.e.*, no external load, no stress in steel.
2. In prestress concrete the stresses in steel is almost constant where as in R.C.C the stress in steel is variable with the lever arm.
3. Prestress concrete has more shear resistance, where as shear resistance of R.C.C is less.
4. In prestress concrete members, deflections are less because the eccentric prestressing force will induce couple which will cause upward deflections, where as in R.C.C., deflections are more.
5. In prestress concrete fatigue resistance is more compare to R.C.C. because in R.C.C. stress in steel is external load dependent where as in P.S.C member it is load independent.
6. Prestress concrete is more durable as high grade of concrete is used which are more dense in nature. R.C.C. is less durable.
7. In prestress concrete dimensions are less because external stresses are counterbalance by the internal stress induced by prestress. Therefore reactions on column & footing are less as a whole the quantity of concrete is reduced by 30% and steel reduced by about 60 to

70%. R.C.C. is uneconomical for long span because in R.C.C. dimension of sections are large requiring more concrete & steel. Moreover as self-weight increases more reactions acted on columns & footings, which requires higher sizes.

### **Analysis of Prestress Member:**

#### **Basic assumption:**

1. Concrete is a homogenous material.
2. Within the range of working stress, both concrete & steel behave elastically, notwithstanding the small amount of creep, which occurs in both the materials under the sustained loading.
3. A plane section before bending is assumed to remain plane even after bending, which implies a linear strain distribution across the depth of the member.

#### **Analysis of prestress member:**

The stress due to prestressing alone are generally combined stresses due to the action of direct load bending from an eccentrically applied load. The following notations and sign conventions are used for the analysis of prestress members.

$P$  □ Prestressing force (Positive when compressive)

$E$  - Eccentricity of prestressing force

$M = Pe$  □ Moment

$A$  - Cross-sectional area of the concrete member

$I$  - Second moment of area of the section about its centroid

$Z_t, Z_b$ , - Section modulus of the top & bottom fibre respectively

$f_{top}, f_{bot}$  = Prestress in concrete developed at the top & bottom fibres

$y_b, y_t$ , - Distance of the top & bottom fibre from the centroid of the section

$r$  - Radius of gyration

**(i) Concentric tendon**

In this case, the load is applied concentrically and a compressive stress of magnitude  $(P/A)$  will act throughout the section. Thus the stress will generate in the section as shown in the figure below.

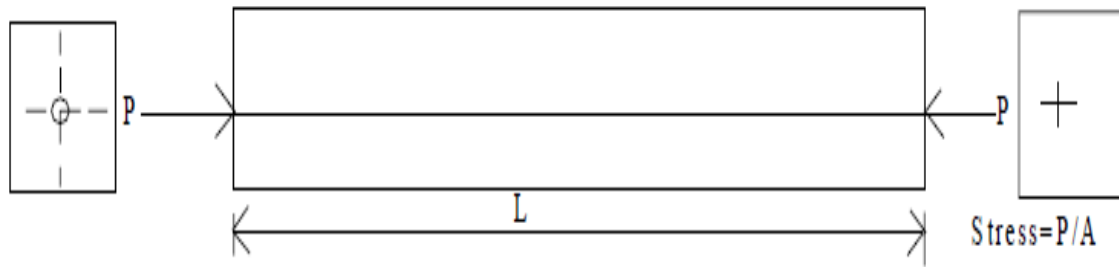

Concentric prestressing

**(ii) Eccentric tendon**

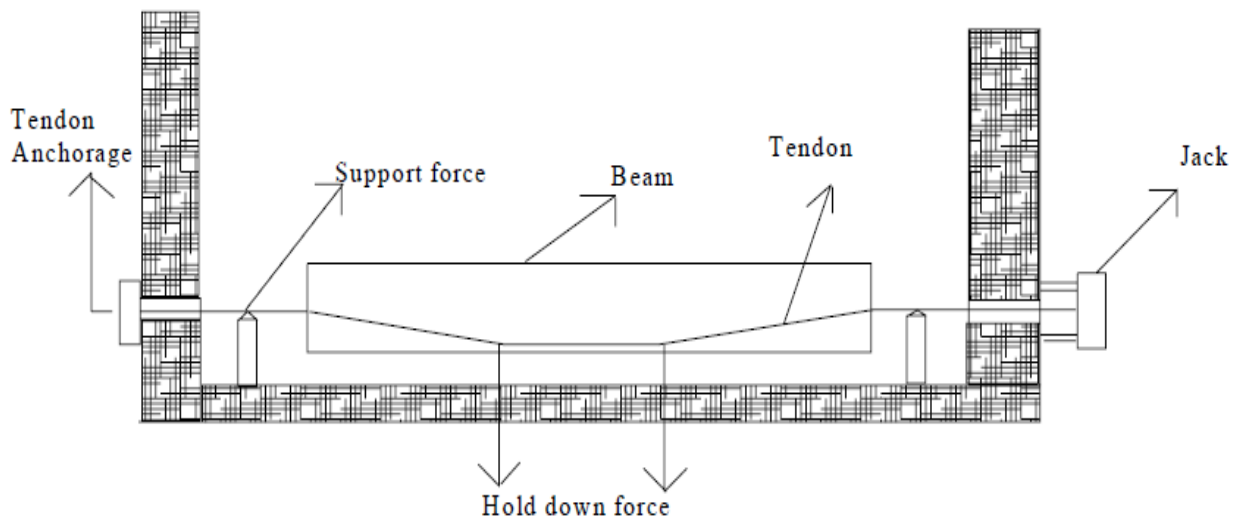

Beam with bend tendon

Thus the stresses developed at the top & bottom fibres of the beam can be written as:

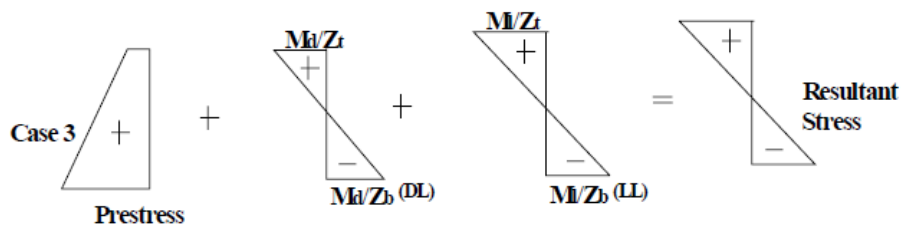
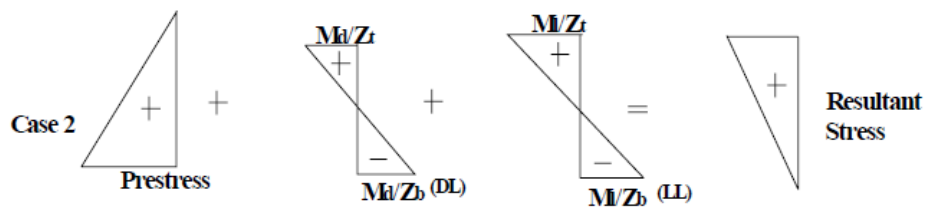
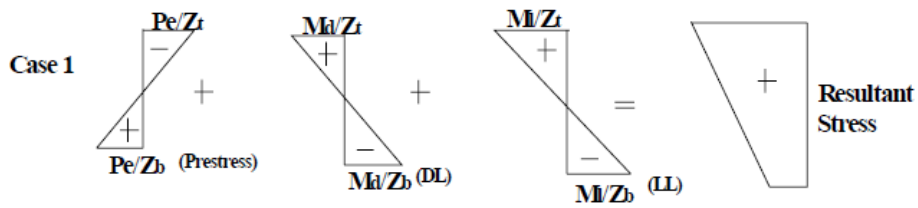
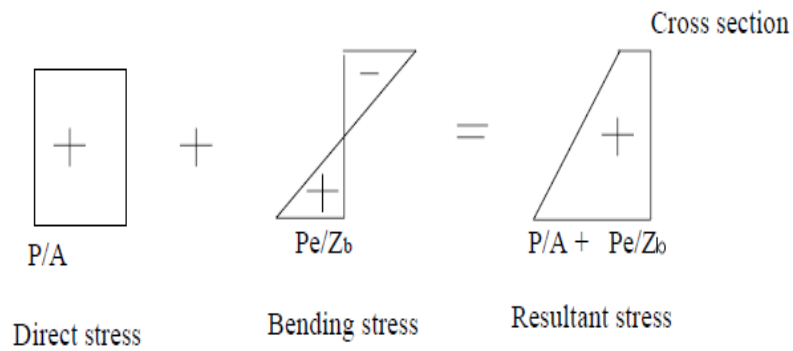
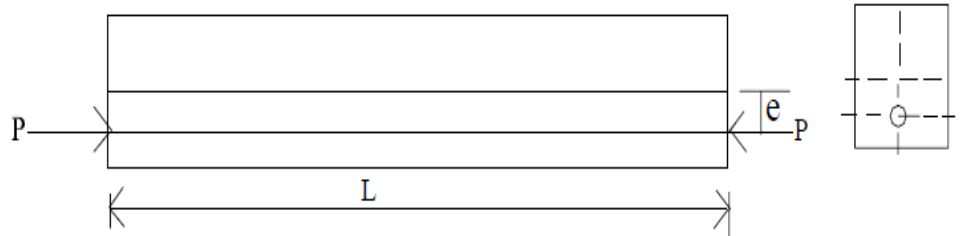

### Example :

A rectangular concrete beam of cross-section 30 cm deep and 20 cm wide is prestressed by means of 15 wires of 5 mm diameter located 6.5 cm from the bottom of the beam and 3 wires of diameter of 5 mm, 2.5 cm from the top. Assuming the prestress in the steel as  $840 \text{ N/mm}^2$ , calculate the stresses at the extreme fibers of the mid-span section when the beam is supporting its own weight over a span of 6 m. If a uniformly distributed live load of  $6 \text{ kN/m}$  is imposed, evaluate the maximum working stress in concrete. The density of concrete is  $24 \text{ kN/m}^3$ .

### Solution:-

Data Provided:

Cross section of beam:  $30 \text{ cm} \times 20 \text{ cm}$

Prestressed by ; 15 no. 5 mm diameter wires (6.5 cm from bottom)

3 no. 5mm diameter wires (2.5 cm from top)

Prestress in steel:  $840 \text{ N/mm}^2$

Span of the beam: 6 m

Density of concrete:  $24 \text{ kN/mm}^2$

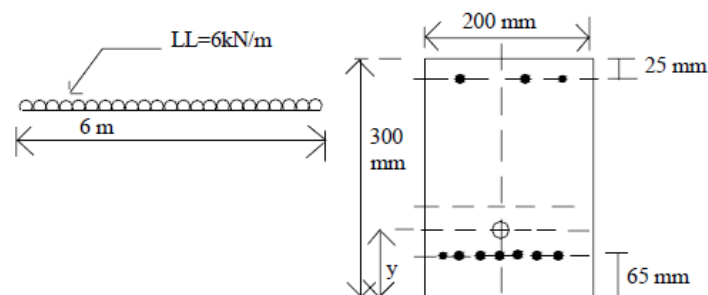

Distance of the centroid of prestressing force from the base

$$y = \left( \frac{(15 \times 65) + (3 \times 275)}{18} \right) = 100 \text{ mm}$$

Eccentricity,  $e = 150 - 100 = 50 \text{ mm}$  Prestressing force,  $P = N (840 \times 18 \times 19.7) = 3 \times 10^5$

Area of concrete section,  $A = (300 \times 200) = 45 \times 10^5 \text{ mm}^2$  Second moment of area,  $I = 200 \times 300^3 / 12 = 45 \times 10^7 \text{ mm}^4$  Section modulus ( $Z_t \& Z_b$ ) =  $(45 \times 10^7 / 150) = 3 \times 10^6 \text{ mm}^3$  Self weight of the beam =  $(0.2 \times 0.3 \times 24) = 1.44 \text{ kN/m}$

$$\text{Moment due to self weight, } M_d = \left( \frac{1.44 \times 6^2}{8} \right) = 6.48 \text{ kNm}$$

$$\text{Live load Moment } M_l = \left( \frac{6 \times 6^2}{8} \right) = 27 \text{ kNm}$$

$$\text{Direct stress due to prestress} = \left( \frac{P}{A} \right) = \left( \frac{3 \times 10^5}{6 \times 10^4} \right) = 5 \text{ N/mm}^2$$

$$\text{Bending stress due to prestress} = \left( \frac{Pe}{Z} \right) = \left( \frac{3 \times 10^5 \times 50}{3 \times 10^6} \right) = 5 \text{ N/mm}^2$$

$$\text{Self weight stress, } \frac{M_d}{Z} = \left( \frac{6.48 \times 10^6}{3 \times 10^6} \right) = 2.16 \text{ N/mm}^2$$

$$\text{Live load stress } \frac{M_l}{Z} = \left( \frac{27 \times 10^6}{3 \times 10^6} \right) = 9 \text{ N/mm}^2$$

The resultant working stresses due to (self weight + prestress + LL) in the concrete

=11.16N/mm<sup>2</sup> (compressive) and 1.16N/mm<sup>2</sup> (tensile)

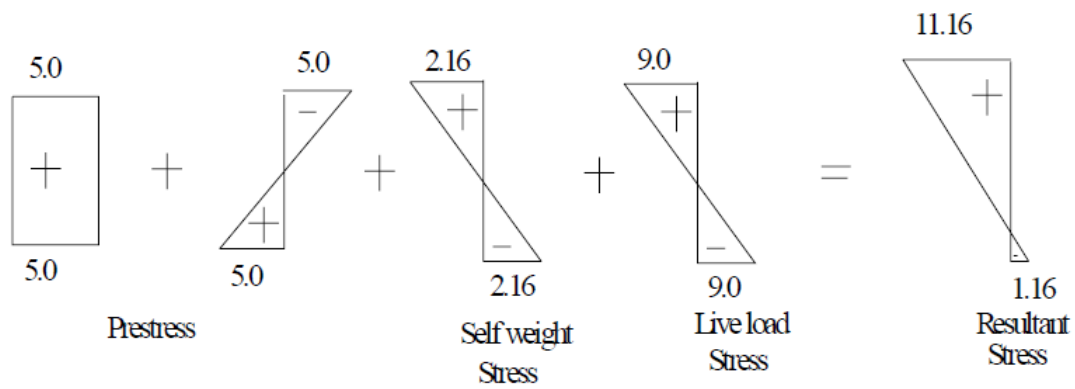



## UNIT-II

### LOSSES OF PRE-STRESS

#### Losses in Prestress

The initial prestressing concrete undergoes a gradual reduction with time from the stages of transfer due to various causes. The force which is used to stretch the wire to the required length must be available all the time as prestressing force if the steel is to be prevented from contracting. Contraction of steel wire occurs due to several causes, effecting reduction in the prestress. This reduction in the prestressing force is called loss in prestress. In a prestressed concrete beam, the loss is due to the following:

#### Types of losses in prestress

##### Pretensioning

During the process of anchoring, the stressed tendon tends to slip before the full grip is established, thus losing some of its imposed strain or in other words, induced stress. This is known as loss due to anchorage draw-in □ From the time the tendons are anchored until transfer of prestressing force to the concrete, the tendons are held between the two abutments at a constant length. The stretched tendons during this time interval will lose some of its induced stress due to the phenomenon known as relaxation of steel. □ As soon as the tendons are cut, the stretched tendons tend to go back to their original state, but are prevented from doing so by the interfacial bond developed between the concrete and the tendons.

1. Elastic deformation of concrete
2. Relaxation of stress in steel
3. Shrinkage of concrete
4. Creep of concrete

## **Post-tensioning**

The tendons are located inside ducts, and the hydraulic jacks held directly against the member. During stressing operation, the tendons tend to get straightened and slide against the duct, thus resulting in the development of a frictional resistance. As a result, the stress in the tendon at a distance away from the jacking end will be smaller than that indicated by the pressure gauge mounted on the jack. This is known as loss due to friction.

With regard to elastic shortening, there will be no loss of prestress if all the tendons are stressed simultaneously because the prestress gauge records the applied stress after the shortening has taken place.

1. No loss due to elastic deformation if all wires are simultaneously tensioned. If the wires are successively tensioned, there will be loss of prestress due to elastic deformation of concrete.
2. Relaxation of stress in steel
3. Shrinkage of concrete
4. Creep of concrete
5. Friction
6. Anchorage slip

### **Loss due to elastic deformation of the concrete**

The loss of prestress due to deformation of concrete depends on the modular ratio & the average stress in concrete at the level of steel.

$f_c$  → Prestress in concrete at the level of steel

$E_s$  → Modulus of elasticity of steel

$E_c$  → Modulus of elasticity of concrete

$\alpha_e$  → Modular ratio

Strain in concrete at the level of steel =  $\frac{f_c}{E_c}$

Stress in steel corresponding to this strain =  $\frac{f_c}{E_c} E_s$

Therefore, Loss of stress in steel =  $\alpha_e f_c$

If the initial stress in steel is known, the percentage loss of stress in steel due to elastic deformation of concrete can be computed.

**Example:** A pre tensioned concrete beam, 100 mm wide and 300 mm deep, is pre stressed by straight wires carrying an initial force of 150 kN at an eccentricity of 50 mm. the modulus of elasticity of steel and concrete are 210 and 35 kN/m<sup>2</sup> respectively. Estimate the percentage loss of stress in steel due to elastic deformation of concrete if the area of steel wires is 188 mm<sup>2</sup>.

**Solution:**

$$P = 150 \text{ kN}$$

$$e = \frac{d}{6} = \frac{300}{6} = 50 \text{ mm}$$

$$A = 100 \times 300 = 3 \times 10^4 \text{ mm}^2$$

$$I = 225 \times 10^6 \text{ mm}^4$$

$$\alpha_e = \frac{E_s}{E_c} = 6$$

$$\text{Initial stress in steel} = \frac{150 \times 10^3}{188} = 800 \text{ N/mm}^2$$

$$\text{Stress in concrete, } f_c = \frac{150 \times 10^3}{3 \times 10^4} + \left[ \frac{150 \times 10^3 \times 50 \times 50}{225 \times 10^6} \right]$$

$$= 6.66 \text{ N/mm}^2$$

$$\begin{aligned} \text{Loss of stress due to elastic deformation of the concrete} &= \alpha_c f_c \\ &= 6 \times 6.66 \\ &= 40 \text{ N/mm}^2 \end{aligned}$$

$$\text{Percentage loss of stress in steel} = \frac{40 \times 100}{800} = 5\%$$

**Example:** A prestressed concrete sleeper produced by pre-tensioning method has a rectangular cross-section of 300mm × 250 mm (b × h). It is prestressed with 9 numbers of straight 7mm diameter wires at 0.8 times the ultimate strength of 1570 N/mm<sup>2</sup>. Estimate the percentage loss of stress due to elastic shortening of concrete. Consider m = 6.

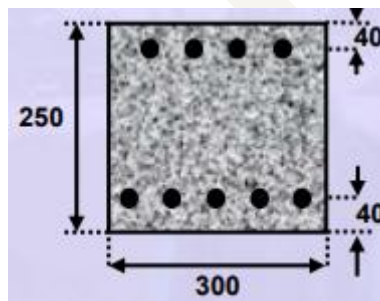

**Solution:**

The sectional properties are calculated as follows.

$$\begin{aligned} \text{Area of a single wire, } A_w &= \pi/4 \times 7^2 \\ &= 38.48 \text{ mm}^2 \end{aligned}$$

$$\begin{aligned} \text{Area of total prestressing steel, } A_p &= 9 \times 38.48 \\ &= 346.32 \text{ mm}^2 \end{aligned}$$

$$\begin{aligned} \text{Area of concrete section, } A &= 300 \times 250 \\ &= 75 \times 10^3 \text{ mm}^2 \end{aligned}$$

$$\begin{aligned} \text{Moment of inertia of section, } I &= 300 \times 250^3 / 12 \\ &= 3.91 \times 10^8 \text{ mm}^4 \end{aligned}$$

Distance of centroid of steel area (CGS) from the soffit,

$$\begin{aligned} y &= \frac{4 \times 38.48 \times (250 - 40) + 5 \times 38.48 \times 40}{9 \times 38.48} \\ &= 115.5 \text{ mm} \end{aligned}$$

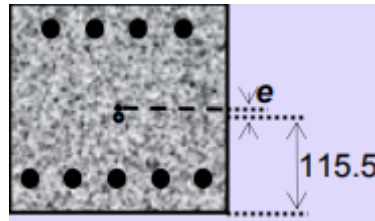

Prestressing force,

$$P_i = 0.8 \times 1570 \times 346.32 \text{ N}$$

$$= 435 \text{ kN}$$

Eccentricity of prestressing force,

$$e = (250/2) - 115.5$$

$$= 9.5 \text{ mm}$$

The stress diagrams due to  $P_i$  are shown.

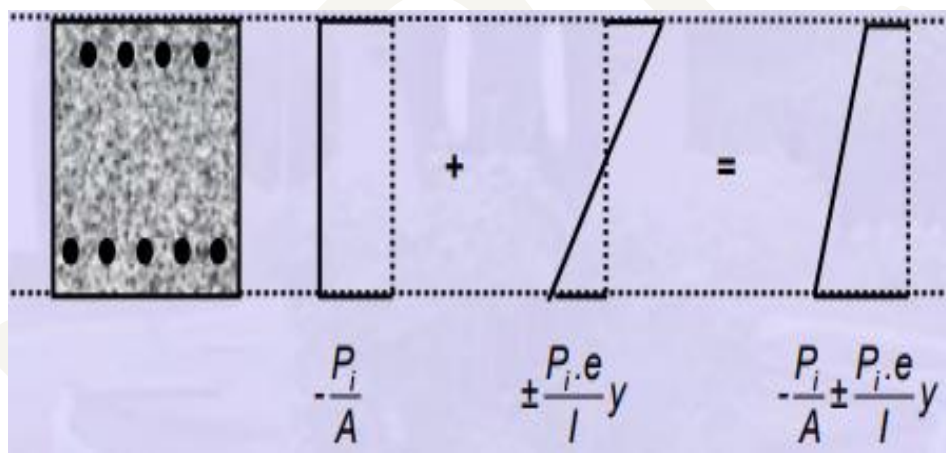

Since the wires are distributed above and below the CGC, the losses are calculated for the top and bottom wires separately.

Stress at level of top wires ( $y = y_t = 125 - 40$ )

$$(f_c)_t = -\frac{P_i}{A} + \frac{P_i \cdot e}{I} y_t$$

$$= \frac{435 \times 10^3}{75 \times 10^3} + \frac{435 \times 10^3 \times 9.5}{3.91 \times 10^8} \times (125 - 40)$$

$$= -4.9 \text{ N/mm}^2$$

Stress at level of bottom wires ( $y = y_b = 125 - 40$ ),

$$(f_c)_t = -\frac{p_i}{A} + \frac{p_i e}{I} y_b$$

$$= -6.7 \text{ N/mm}^2$$

Loss of prestress in top wires =  $m f_c A_p$

(in terms of force)  $= 6 \times 4.9 \times (4 \times 38.48)$

$$= 4525.25 \text{ N}$$

Loss of prestress in bottom wires =  $6 \times 6.7 \times (5 \times 38.48)$

$$= 7734.48 \text{ N}$$

Total loss of prestress =  $4525 + 7735$

$$= 12259.73 \text{ N}$$

$$\approx 12.3 \text{ kN}$$

Percentage loss =  $(12.3 / 435) \times 100\%$

$$= 2.83\%$$

### **Loss due to shrinkage of concrete :**

Factors affecting the shrinkage in concrete

1. The loss due to shrinkage of concrete results in shortening of tensioned wires & hence contributes to the loss of stress.
2. The shrinkage of concrete is influenced by the type of cement, aggregate & the method of curing used.
3. Use of high strength concrete with low water cement ratio results in reduction in shrinkage and consequent loss of prestress.
4. The primary cause of drying shrinkage is the progressive loss of water from concrete.
5. The rate of shrinkage is higher at the surface of the member.
6. The differential shrinkage between the interior surfaces of large member may result in strain gradients leading to surface cracking.

Hence, proper curing is essential to prevent cracks due to shrinkage in prestress members. In the case of pretensioned members, generally moist curing is restored in order to prevent shrinkage until the time of transfer. Consequently, the total residual shrinkage strain will be larger in pretensioned members after transfer of prestress in comparison with post-tensioned members, where a portion of shrinkage will have already taken place by the time of transfer of stress. This aspect has been considered in the recommendation made by the code (IS:1343) for the loss of prestress due to shrinkage of concrete and is obtained below:

$$\begin{aligned} \varepsilon_{cs} \rightarrow \text{Total residual shrinkage strain} &= 300 \times 10^{-6} \text{ for pre-tensioning and} \\ &= \left[ \frac{200 \times 10^{-6}}{\log_{10}(t+2)} \right] \text{ for post-tensioning.} \end{aligned}$$

Where,

$t \rightarrow$  Age of concrete at transfer in days.

Then, the loss of stress =  $\varepsilon_{cs} E_s$

Here,  $E_s \rightarrow$  Modulus of elasticity of steel

### Loss due to creep of concrete

The sustained prestress in the concrete of a prestress member results in creep of concrete which is effectively reduces the stress in high tensile steel. The loss of stress in steel due to creep of concrete can be estimated if the magnitude of ultimate creep strain or creep-coefficient is known.

#### 1. Ultimate Creep strain method

The loss of stress in steel due to creep of concrete =  $\varepsilon_{cc} f_c E_s$

Where,  $\varepsilon_{cc} \rightarrow$  Ultimate creep strain for a sustained unit stress.

$f_c \rightarrow$  Compressive stress in concrete at the level of steel

$E_s \rightarrow$  Modulus of elasticity of steel

## 2. Creep Coefficient Method

$$\text{Creep coefficient} = \frac{\text{Creep strain}}{\text{Elastic strain}} = \frac{\varepsilon_c}{\varepsilon_e}$$

$$\text{Therefore, loss of stress in steel} = \varepsilon_c E_s = \phi \varepsilon_e E_s = \phi \left( \frac{f_c}{E_c} \right) E_s = \phi f_c \alpha_e$$

Where,  $\phi \rightarrow$  Creep Coefficient

$\varepsilon_c \rightarrow$  Creep strain

$\varepsilon_e \rightarrow$  Elastic strain

$\alpha_e \rightarrow$  Modular ratio

$f_c \rightarrow$  Stress in concrete

$E_c \rightarrow$  Modulus of elasticity of concrete

$E_s \rightarrow$  Modulus of elasticity of steel

The magnitude of creep coefficient varies depending upon the humidity, concrete quality, duration of applied loading and the age of concrete when loaded. The general value recommended varies from 1.5 for watery situation to 4.0 for dry conditions with a relative humidity of 35%.

### **Loss due to relaxation of stress in steel**

Most of the codes provide for the loss of stress due to relaxation of steel as a percentage of initial stress in steel. The BIS recommends a value varying from 0 to 90 N/mm<sup>2</sup> for stress in wires varying from

$$0.5 f_{pu} \text{ to } 0.8 f_{pu}$$

Where,  $f_{pu} \rightarrow$  Characteristic strength of pre-stressing tendon.

### **Loss of stress due to friction:**

The magnitude of loss of stress due to friction is of following types: -



- a. Loss due to curvature effect, which depends upon the tendon form or alignment, which generally follows a curved profile along the length of the beam.
- b. Loss of stress due to wobble effect, which depends upon the local deviations in the alignment of the cable. The wobble or wave effect is the result of accidental or unavoidable misalignment, since ducts or sheaths cannot be perfectly located to follow a predetermined profile throughout the length of beam.

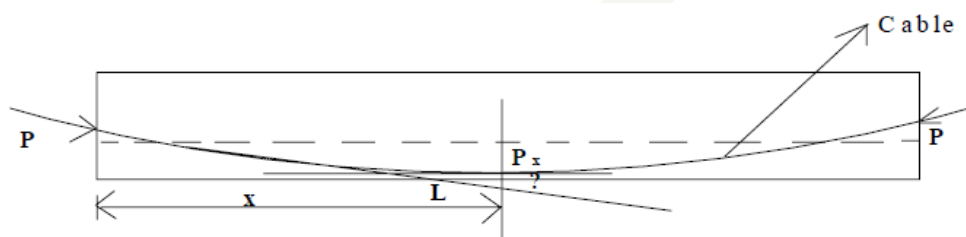

$$P_x = P_o e^{-(\mu\alpha + kx)}$$

Where,

$P_o$  -The Prestressing force at the jacking end.

$M$  - Coefficient of friction between cable and duct

$A$  - The cumulative angle in radians through the tangent to the cable profile has turned between any two points under consideration.

$k$ - Friction coefficient for wave effect.

The IS code recommends the following value for  $k$

$k = 0.15$  per 100 m for normal condition

$= 1.5$  per 100 m for thin walled ducts where heavy vibration are encountered and in other adverse conditions.

### Loss due to Anchorage slip :

The magnitude of loss of stress due to the slip in anchorage is computed as follows: -

If  $\Delta$  slip of anchorage, in mm

$L$  -Length of the cable, in mm

$A$ -Cross-sectional area of the cable in mm<sup>2</sup>

$E_s$  - Modulus of elasticity of steel in N/mm<sup>2</sup>

$P$  -Prestressing force in the cable, in N

$$\Delta = PL / A E_s$$

Hence, Loss of stress due to anchorage slip=  $\frac{P}{A} = \frac{E_s \Delta}{L}$  ;

### Pressure line or thrust line :

In prestress, the combined effect of prestressing force & external load can be resolved into a single force. The locus of the points of application of this force in any structure is termed as the pressure line or thrust line. The load here is such that stress at top fiber of support & bottom fiber of the central span is zero.

Let us consider a beam which is prestressed by a force  $P$  at a constant eccentricity  $e$ . The magnitude of load & eccentricity is such that the stress at the bottom fiber at the mid span is zero. It is possible if the eccentricity is  $e = d/6$  it can be seen from the resultant stress distribution at the support due to a prestressing force  $P$  at an eccentricity  $e = d/6$  & bending moment zero is equivalent to a force  $P$  applied at an eccentricity  $e = d/6$ . At quarter span the resultant stress distribution due force  $P$  applied at an eccentricity  $e = d/12$ . Similarly, at mid span the resultant stress distribution due to a force  $P$  at an eccentricity  $e = d/6$  & BM due to uniformly distributed load is equivalent to a force  $P$  applied at an eccentricity  $e = -d/6$ .

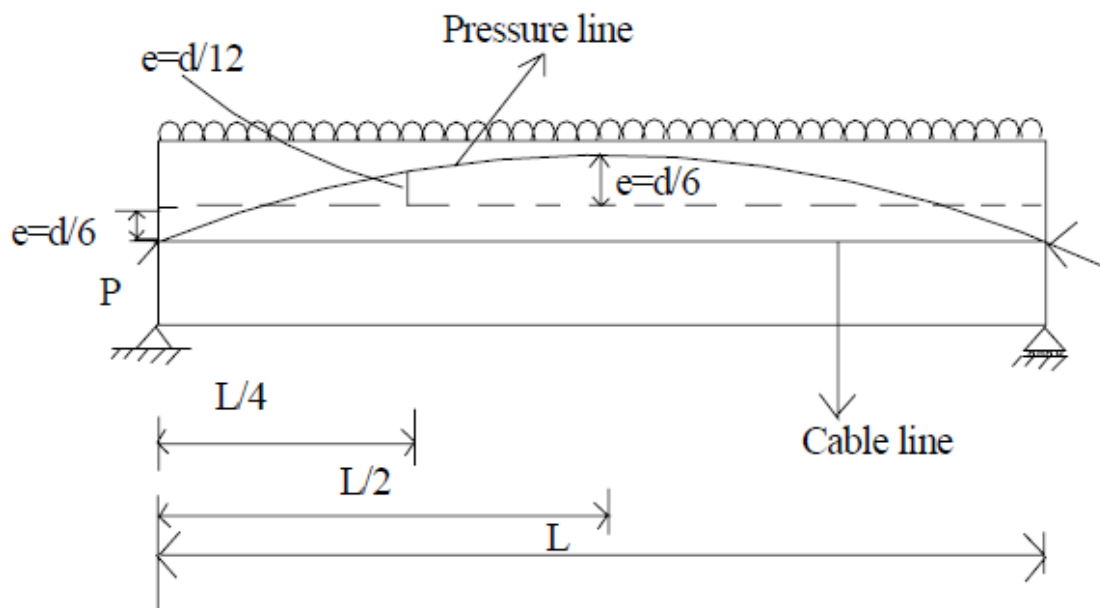

## **UNIT – III**

### **FLEXURE**

#### **Analysis of Members under Flexure**

##### **Introduction**

Similar to members under axial load, the analysis of members under flexure refers to the evaluation of the following.

- 1) Permissible prestress based on allowable stresses at transfer.
- 2) Stresses under service loads. These are compared with allowable stresses under service conditions.
- 3) Ultimate strength. This is compared with the demand under factored loads.
- 4) The entire load versus deformation behaviour.

The analyses at transfer and under service loads are presented in this section.

The evaluation of the load versus deformation behaviour is required in special type of analysis.

##### **Assumptions**

The analysis of members under flexure considers the following.

1. Concrete is a homogeneous elastic material.
2. Within the range of working stress, both concrete & steel behave elastically, not withstanding the small amount of creep, which occurs in both the materials under the sustained loading.

3. A plane section before bending is assumed to remain plane even after bending, which implies a linear strain distribution across the depth of the member.
4. Prestress Concrete is one in which there have been introduced internal stresses of such magnitude and distribution that stresses resulting from given external loading is counter balanced to a desired degree.
5. Plane sections remain plane till failure (known as Bernoulli's hypothesis).
6. Perfect bond between concrete and prestressing steel for bonded tendons.

### **Principles of Mechanics**

The analysis involves three principles of mechanics.

- 1) **Equilibrium** of internal forces with the external loads. The compression in concrete ( $C$ ) is equal to the tension in the tendon ( $T$ ). The couple of  $C$  and  $T$  are equal to the moment due to external loads.
- 2) **Compatibility** of the strains in concrete and in steel for bonded tendons. The formulation also involves the first assumption of plane section remaining plane after bending. For unbonded tendons, the compatibility is in terms of deformation.
- 3) **Constitutive** relationships relating the stresses and the strains in the materials.

### **Variation of Internal Forces**

In reinforced concrete members under flexure, the values of compression in concrete ( $C$ ) and tension in the steel ( $T$ ) increase with increasing external load. The change in the lever arm ( $z$ ) is not large.

In prestressed concrete members under flexure, at transfer of prestress  $C$  is located close to  $T$ . The couple of  $C$  and  $T$  balance only the self weight. At service loads,  $C$  shifts up and the lever arm ( $z$ ) gets large. The variation of  $C$  or  $T$  is not appreciable.

The following figure explains this difference schematically for a simply supported beam under uniform load.

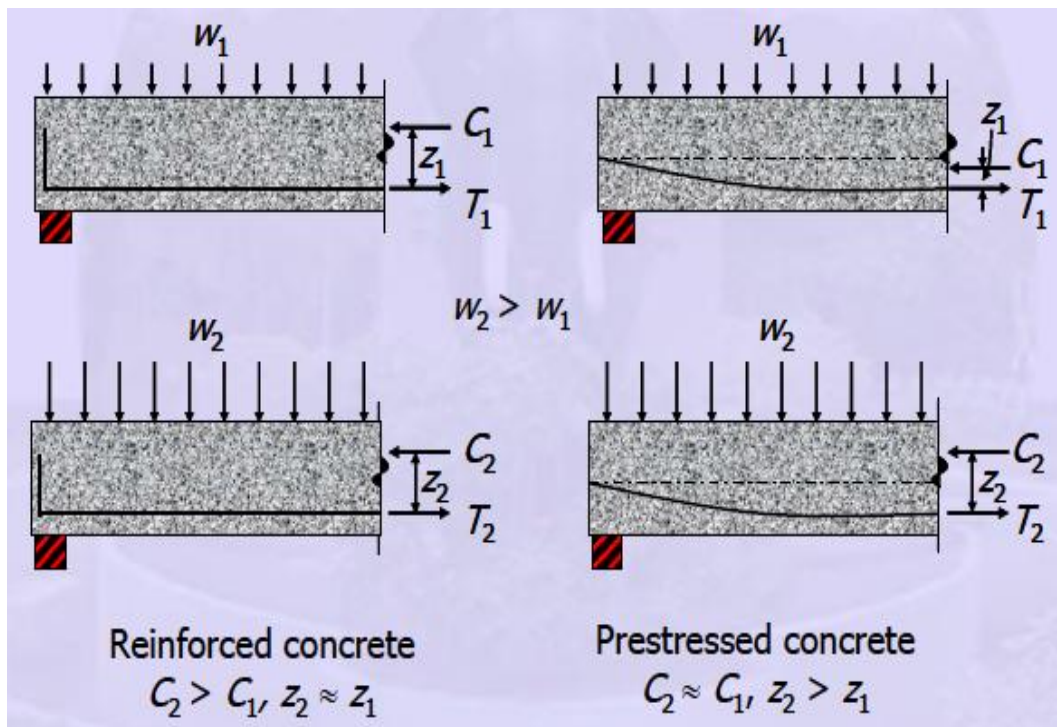

$C_1, T_1$  = compression and tension at transfer due to self weight

$C_2, T_2$  = compression and tension under service loads

$w_1$  = self weight

$w_2$  = service loads

$z_1$  = lever arm at transfer

$z_2$  = lever arm under service loads.

## **Analysis at Transfer and at Service**

The analysis at transfer and under service loads are similar. Hence, they are presented together. A prestressed member usually remains uncracked under service loads. The concrete and steel are treated as elastic materials. The principle of superposition is applied. The increase in stress in the prestressing steel due to bending is neglected.

There are three approaches to analyse a prestressed member at transfer and under service loads. These approaches are based on the following concepts.

- a) Based on stress concept.
- b) Based on force concept.
- c) Based on load balancing concept.

The following material explains the three concepts.

### **Based on Stress Concept**

In the approach based on stress concept, the stresses at the edges of the section under the internal forces in concrete are calculated. The stress concept is used to compare the calculated stresses with the allowable stresses.

The following figure shows a simply supported beam under a uniformly distributed load (UDL) and prestressed with constant eccentricity ( $e$ ) along its length.

The first stress profile is due to the compression  $P$ . The second profile is due to the eccentricity of the compression. The third profile is due to the moment. At transfer, the moment is due to self weight. At service the moment is due to service loads.

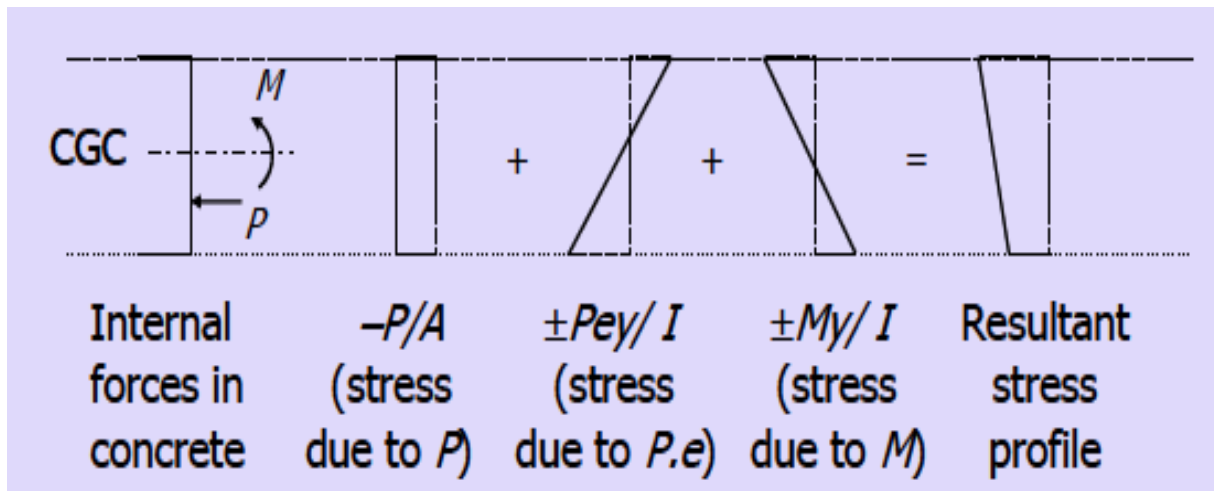

Stress profiles at a section due to internal forces

The resultant stress at a distance  $y$  from the CGC is given by the principle of superposition as follows.

$$f = -\frac{P}{A} \pm \frac{Pe y}{I} \pm \frac{M y}{I}$$

### Based on Force Concept

The approach based on force concept is analogous to the study of reinforced concrete. The tension in prestressing steel ( $T$ ) and the resultant compression in concrete ( $C$ ) are considered to balance the external loads. This approach is used to determine the dimensions of a section and to check the service load capacity. Of course, the stresses in concrete calculated by this approach are same as those calculated based on stress concept. The stresses at the extreme edges are compared with the allowable stresses.

The following figures show the internal forces in the section.



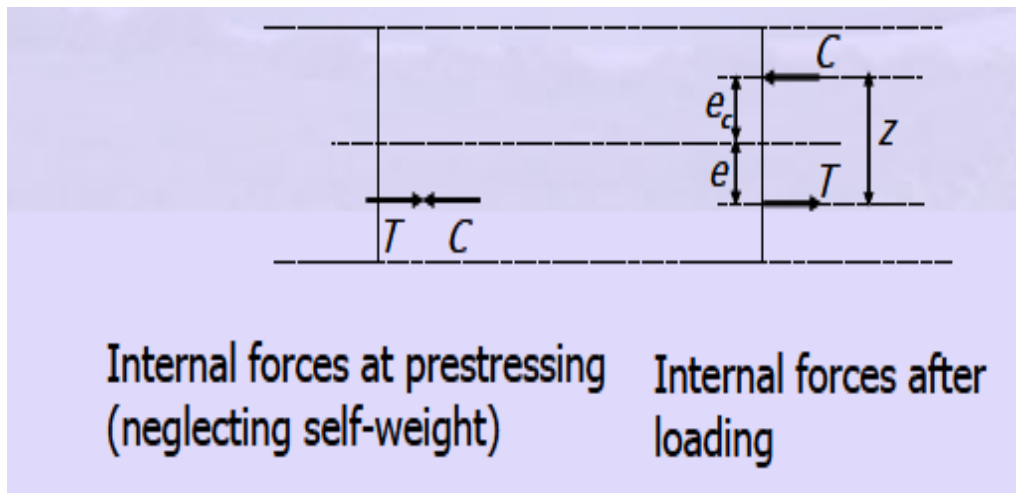

The equilibrium equations are as follows.

$$C = T$$

$$M = C \cdot z$$

$$M = C(e + e_c)$$

The resultant stress in concrete at distance  $y$  from the CGC is given as follows.

$$f = -\frac{C}{A} \pm \frac{C e_c y}{I}$$

Substituting  $C = P$  and  $C e_c = M - P e$ ,

the expression of stress becomes same as that given by the stress concept.

$$f = -\frac{P}{A} \pm \frac{P e y}{I} \pm \frac{M y}{I}$$

**Based on Load Balancing Concept :**

The approach based on load balancing concept is used for a member with curved or harped tendons and in the analysis of indeterminate continuous beams. The moment, upward thrust

and upward deflection (camber) due to the prestress in the tendons are calculated. The upward thrust balances part of the superimposed load.

The expressions for three profiles of tendons in simply supported beams are given.

a) For a Parabolic Tendon

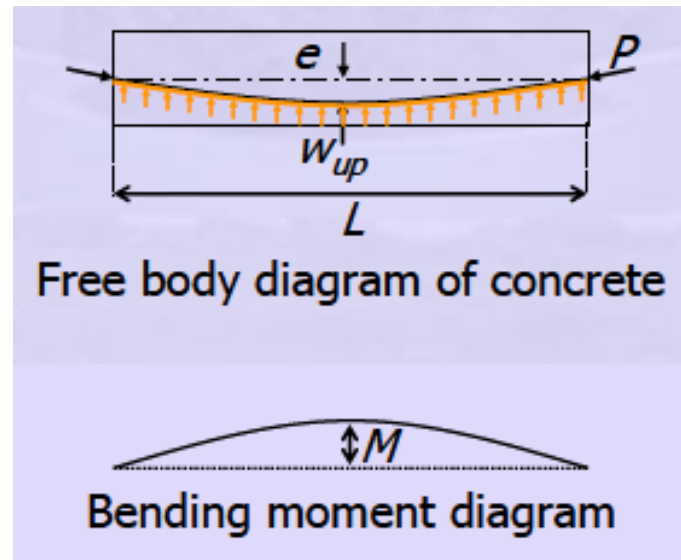

Simply supported beam with parabolic tendon

The moment at the centre due to the uniform upward thrust ( $w_{up}$ ) is given by the following equation.

$$M = \frac{w_{up}L^2}{8}$$

The moment at the centre from the prestressing force is given as  $M = Pe$ . The expression of  $w_{up}$  is calculated by equating the two expressions of  $M$ . The upward deflection ( $\Delta$ ) can be calculated from  $w_{up}$  based on elastic analysis.

b) For Singly Harped Tendon

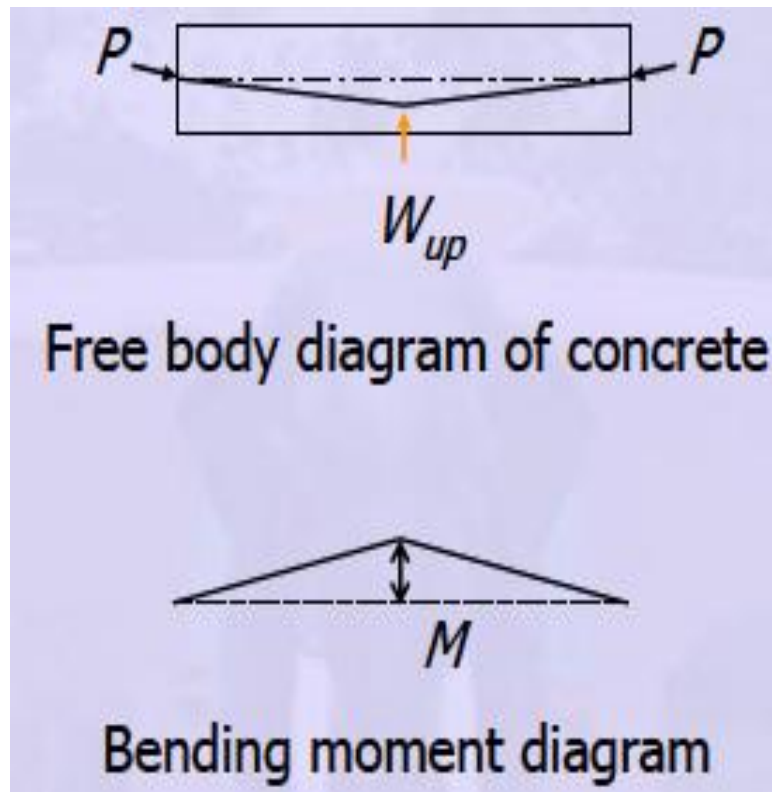

Simply supported beam with singly harped tendon

The moment at the centre due to the upward thrust ( $W_{up}$ ) is given by the following equation.

It is equated to the moment due to the eccentricity of the tendon. As before, the upward thrust and the deflection can be calculated.

$$M = \frac{W_{up}L}{4} = Pe$$

$$W_{up} = \frac{4Pe}{L}$$

$$\Delta = \frac{W_{up}L^3}{48EI}$$

c) For Doubly Harped Tendon

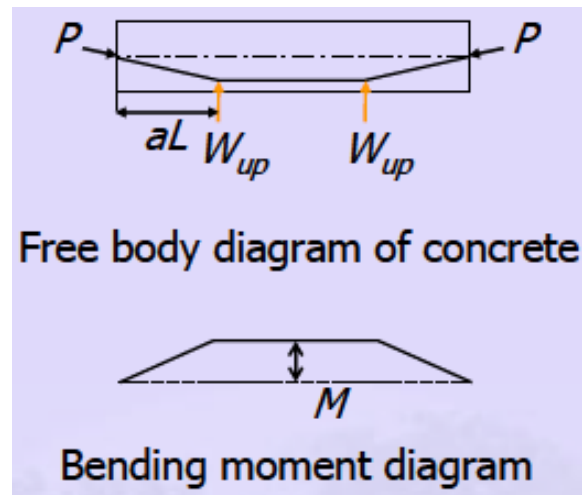

### Simply supported beam with doubly harped tendon

The moment at the centre due to the upward thrusts ( $W_{up}$ ) is given by the following equation.

It is equated to the moment due to the eccentricity of the tendon. As before, the upward thrust and the deflection can be calculated.

$$M = W_{up} aL = Pe$$

$$W_{up} = \frac{Pe}{aL}$$

$$\Delta = \frac{a(3 - 4a^2) W_{up} L^3}{24EI}$$

## Analysis for Shear

### Introduction:

The analysis of reinforced concrete and prestressed concrete members for shear is more difficult compared to the analyses for axial load or flexure.

The analysis for axial load and flexure are based on the following principles of mechanics.

- 1) **Equilibrium** of internal and external forces
- 2) **Compatibility** of strains in concrete and steel
- 3) **Constitutive relationships** of materials.

The conventional analysis for shear is based on equilibrium of forces by a simple equation. The compatibility of strains is not considered. The constitutive relationships (relating stress and strain) of the materials, concrete or steel, are not used. The strength of each material corresponds to the ultimate strength. The strength of concrete under shear although based on test results, is empirical in nature.

Shear stresses generate in beams due to bending or twisting. The two types of shear stress are called flexural shear stress and torsional shear stress, respectively.

### Stresses in an Uncracked Beam

The following figure shows the variations of shear and moment along the span of a simply supported beam under a uniformly distributed load. The variations of normal stress and shear stress along the depth of a section of the beam are also shown.

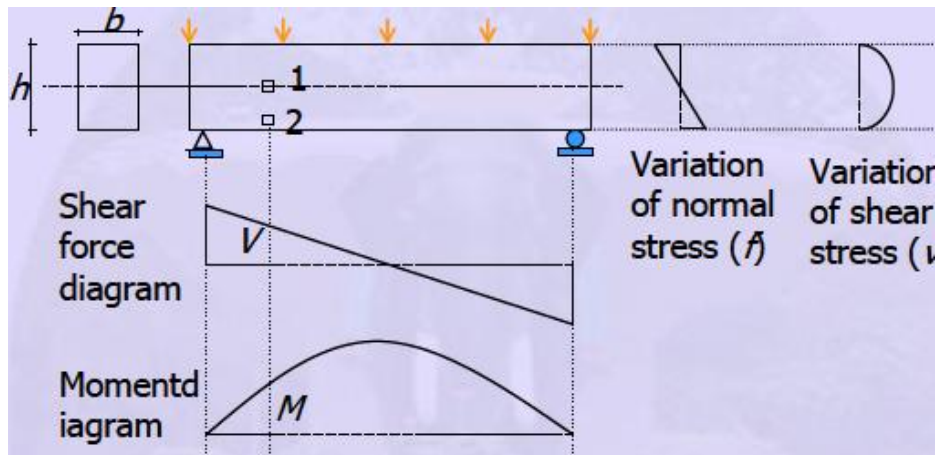

### Variations of forces and stresses in a simply supported beam

Under a general loading, the shear force and the moment vary along the length. The normal stress and the shear stress vary along the length, as well as along the depth. The combination of the normal and shear stresses generate a two-dimensional stress field at a point. At any point in the beam, the state of two-dimensional stresses can be expressed in terms of the principal stresses. The Mohr's circle of stress is helpful to understand the state of stress.

Before cracking, the stress carried by steel is negligible. When the principal tensile stress exceeds the cracking stress, the concrete cracks and there is redistribution of stresses between concrete and steel. For a point on the neutral axis (Element 1), the shear stress is maximum and the normal stress is zero. The principal tensile stress ( $\sigma_1$ ) is inclined at  $45^\circ$  to the neutral axis. The following figure shows the state of in-plane stresses.

#### Calculation of Shear Demand :

The objective of design is to provide ultimate resistance for shear ( $V_{uR}$ ) greater than the shear demand under ultimate loads ( $V_u$ ). For simply supported prestressed beams, the maximum shear near the support is given by the beam theory. For continuous prestressed

beams, a rigorous analysis can be done by the moment distribution method. Else, the shear coefficients in Table 13 of IS:456 - 2000 can be used under conditions of uniform cross-section of the beams, uniform loads and similar lengths of span.

### Design of Stirrups

The design is done for the critical section. The critical section is defined in Clause 22.6.2 of IS:456 - 2000. In general cases, the face of the support is considered as the critical section. When the reaction at the support introduces compression at the end of the beam, the critical section can be selected at a distance effective depth from the face of the support. The effective depth is selected as the greater of  $d_p$  or  $d_s$ .

$d_p$  = depth of CGS from the extreme compression fiber

$d_s$  = depth of centroid of non-prestressed steel.

Since the CGS is at a higher location near the support, the effective depth will be equal to  $d_s$ .

To vary the spacing of stirrups along the span, other sections may be selected for design. Usually the following scheme is selected for beams under uniform load.

- 1) Close spacing for quarter of the span adjacent to the supports.
- 2) Wide spacing for half of the span at the middle.

For large beams, more variation of spacing may be selected. The following sketch shows the typical variation of spacing of stirrups. The span is represented by  $L$ .

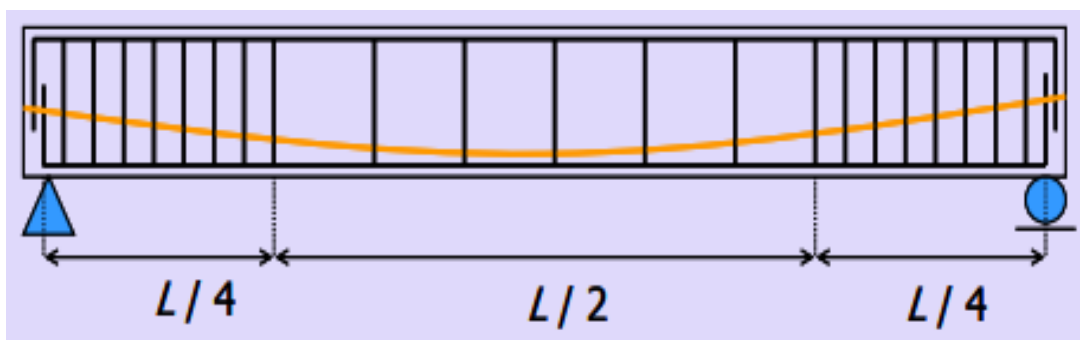

Figure 5-2.1 Typical variation of spacing of stirrups

### Design of Transverse Reinforcement :

When the shear demand ( $V_u$ ) exceeds the shear capacity of concrete ( $V_c$ ), transverse reinforcements in the form of stirrups are required. The stirrups resist the propagation of diagonal cracks, thus checking diagonal tension failure and shear tension failure. The stirrups resist a failure due to shear by several ways.

The functions of stirrups are listed below.

- 1) Stirrups resist part of the applied shear.
- 2) They restrict the growth of diagonal cracks.
- 3) The stirrups counteract widening of the diagonal cracks, thus maintaining aggregate interlock to a certain extent.
- 4) The splitting of concrete cover is restrained by the stirrups, by reducing dowel forces in the longitudinal bars.

After cracking, the beam is viewed as a plane truss. The top chord and the diagonals are made of concrete struts. The bottom chord and the verticals are made of steel reinforcement ties.

Based on this truss analogy, for the ultimate limit state, the total area of the legs of the stirrups ( $A_{sv}$ ) is given as follows.

$$\frac{A_{sv}}{s_v} = \frac{V_u - V_c}{0.87 f_y d_t}$$

The notations in the above equation are explained.

$s_v$  = spacing of the stirrups



$d_t = \text{greater of } d_p \text{ or } d_s$

$d_p = \text{depth of CGS from the extreme compression fiber}$

$d_s = \text{depth of centroid of non-prestressed steel}$

$f_y = \text{yield stress of the stirrups}$

The grade of steel for stirrups should be restricted to Fe 415 or lower.

### Design of Stirrups for Flanges

For flanged sections, although the web carries the vertical shear stress, there is shear stress in the flanges due to the effect of shear lag. Horizontal reinforcement in the form of single leg or closed stirrups is provided in the flanges. The following figure shows the shear stress in the flange at the face of the web.

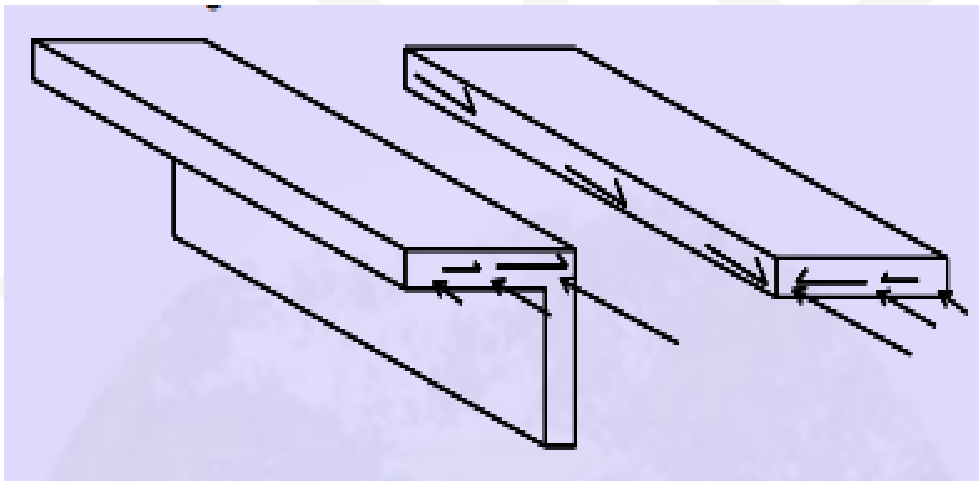

Figure 5-3.1 Shear stress in flange due to shear lag effect

The horizontal reinforcement is calculated based on the shear force in the flange. The relevant quantities for the calculation based on an elastic analysis are as follows.

- 1) Shear flow (shear stress  $\times$  width)
- 2) Variation of shear stress in a flange ( $\tau_f$ )
- 3) Shear forces in flanges ( $V_f$ ).

#### 4) Ultimate vertical shear force ( $V_u$ )

The following sketch shows the above quantities for an I-section (with flanges of constant widths).

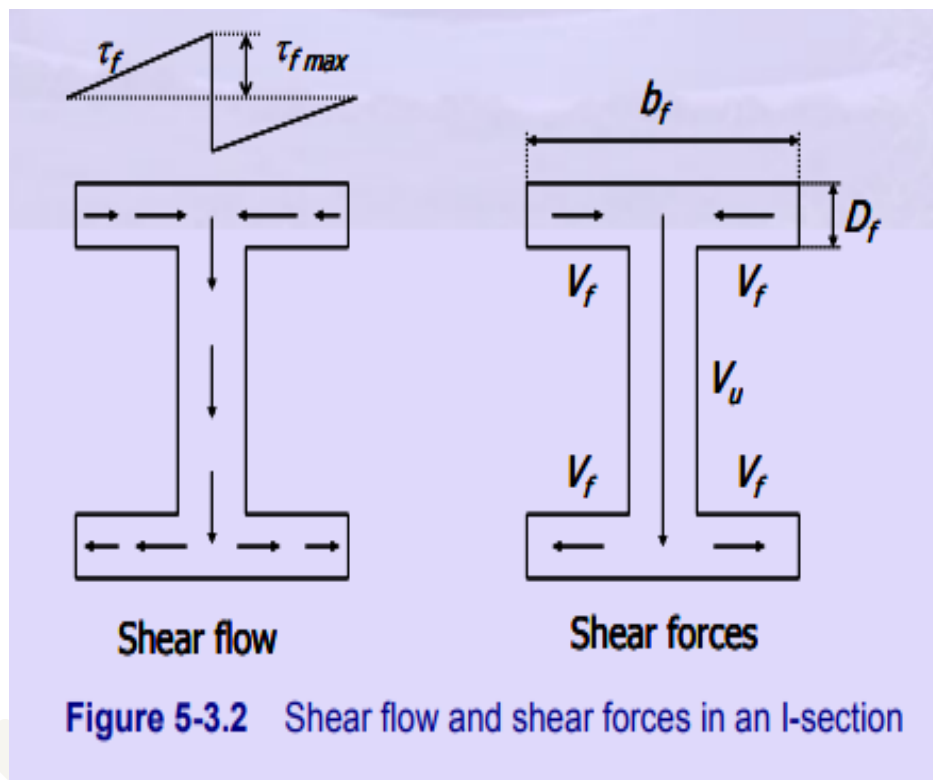

The design shear force in a flange is given as follows.

$$V_f = \frac{\tau_{f,max}}{2} \frac{b_f}{2} D_f$$

Here,

$b_f$  = breadth of the flange

$D_f$  = depth of the flange

$\tau_{f,max}$  = maximum shear stress in the flange.

The maximum shear stress in the flange is given by an expression similar to that for the shear stress in web

$$\tau_{f \max} = \frac{V_u A_1 \bar{y}}{I D_f}$$

Here,

$V_u$  = ultimate vertical shear force

$I$  = moment of inertia of the section.

$A_1$  = area of half of the flange

$\bar{y}$  = distance of centroid of half of the flange from the neutral axis at CGC.

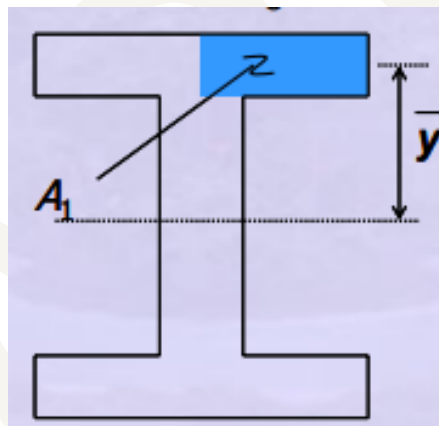

Figure :Cross-section of a beam showing the variables for calculating shear stress in the flange

The amount of horizontal reinforcement in the flange ( $A_{svf}$ ) is calculated from  $V_f$ .

$$A_{svf} = \frac{V_f}{0.87 f_y}$$

The yield stress of the reinforcement is denoted as  $f_y$  .

## UNIT-IV

### TRANSFER OF PRESTRESS IN PRETENSIONED MEMBERS

#### Transmission of Prestress

#### Pre-tensioned Members

The stretched tendons transfer the prestress to the concrete leading to a self equilibrating system. The mechanism of the transfer of prestress is different in the pre-tensioned and post-tensioned members. The transfer or transmission of prestress is explained for the two types of members separately.

For a pre-tensioned member, usually there is no anchorage device at the ends. The following photo shows that there is no anchorage device at the ends of the pre-tensioned railway sleepers.

For a pre-tensioned member without any anchorage at the ends, the prestress is transferred by the bond between the concrete and the tendons. There are three mechanisms in the bond.

- 1) Adhesion between concrete and steel
- 2) Mechanical bond at the concrete and steel interface



**Figure:**End of pre-tensioned railway sleepers

### 3) Friction in presence of transverse compression.

The mechanical bond is the primary mechanism in the bond for indented wires, twisted strands and deformed bars. The surface deformation enhances the bond. Each of the type is illustrated below.

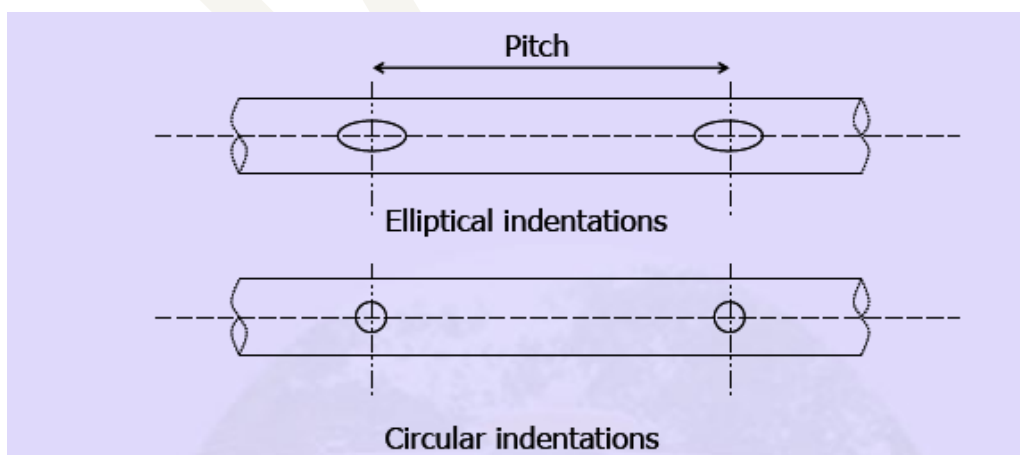

The prestress is transferred over a certain length from each end of a member which is called the **transmission length** or **transfer length** ( $L_t$ ). The stress in the tendon is zero at the ends of the members. It increases over the transmission length to the effective prestress ( $f_{pe}$ ) under service loads and remains practically constant beyond it. The following figure shows the variation of prestress in the tendon.

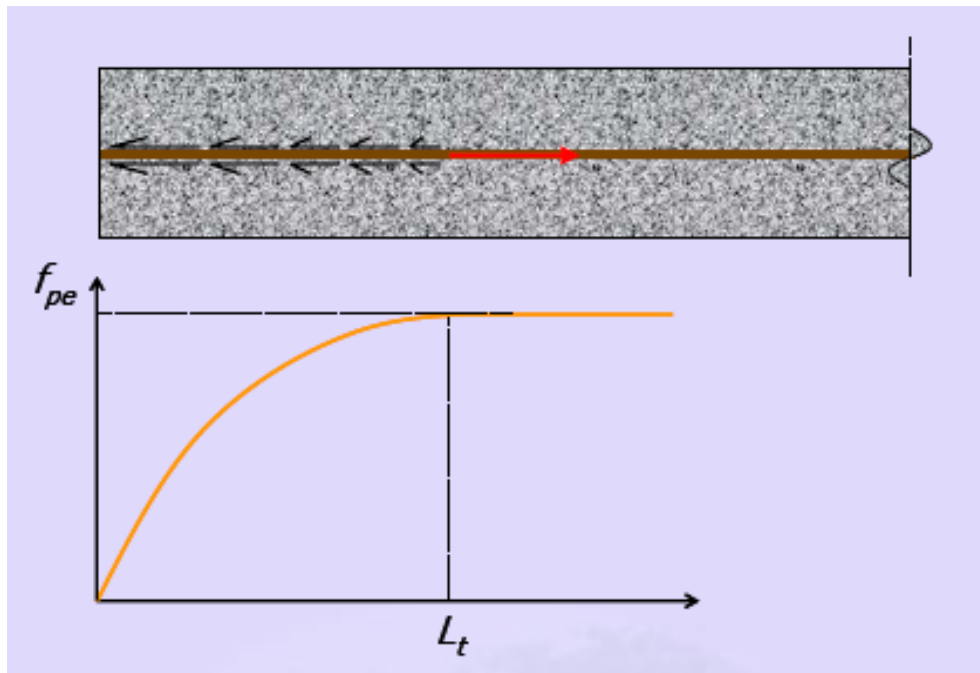

Figure :Variation of prestress in tendon along transmission length

### Hoyer Effect :

After stretching the tendon, the diameter reduces from the original value due to the Poisson's effect. When the prestress is transferred after the hardening of concrete, the ends of the tendon sink in concrete. The prestress at the ends of the tendon is zero. The diameter of the tendon regains its original value towards the end over the transmission length. The change of diameter from the original value (at the end) to the reduced value (after the transmission length), creates a wedge effect in concrete. This helps in the transfer of prestress from the

tendon to the concrete. This is known as the Hoyer effect. The following figure shows the sequence of the development of Hoyer effect.

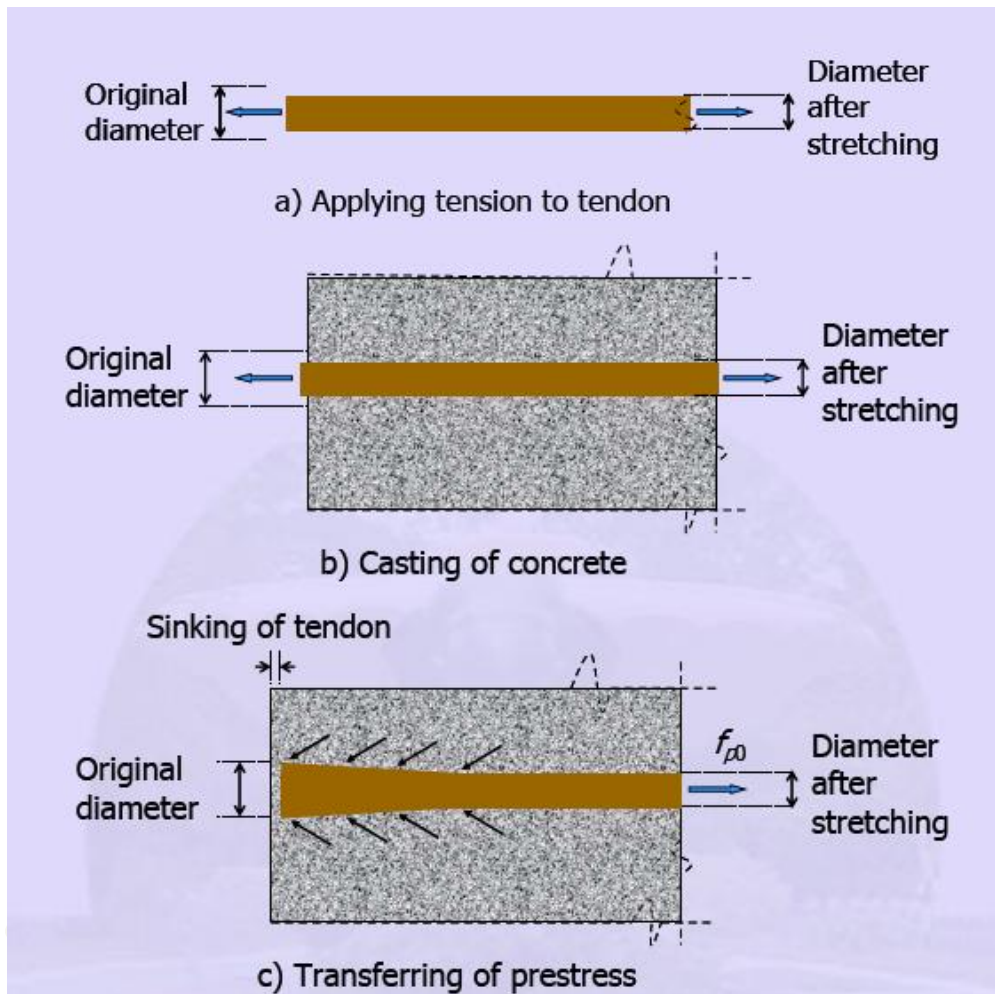

Figure: Transfer of Prestress

Since there is no anchorage device, the tendon is free of stress at the end. The concrete should be of good quality and adequate compaction for proper transfer of prestress over the transmission length.

### Transmission Length

There are several factors that influence the transmission length. These are as follows.

- 1) Type of tendon

- wire, strand or bar
- 2) Size of tendon
  - 3) Stress in tendon
  - 4) Surface deformations of the tendon
    - Plain, indented, twisted or deformed
  - 5) Strength of concrete at transfer
  - 6) Pace of cutting of tendons
    - Abrupt flame cutting or slow release of jack
  - 7) Presence of confining reinforcement
  - 8) Effect of creep
  - 9) Compaction of concrete
  - 10) Amount of concrete cover

The transmission length needs to be calculated to check the adequacy of prestress in the tendon over the length. A section with high moment should be outside the transmission length, so that the tendon attains at least the design effective prestress ( $f_{pe}$ ) at the section. The shear capacity at the transmission length region has to be based on a reduced effective prestress.

**IS:1343 - 1980** recommends values of transmission length in absence of test data. These values are applicable when the concrete is well compacted, its strength is not less than  $35 \text{ N/mm}^2$  at transfer and the tendons are released gradually. The recommended values of transmission length are as follows.



### Values of transmission length

For plain and intended wires	$L_t = 100 \phi$
For crimped wire	$L_t = 65 \phi$
For strands	$L_t = 30 \phi$

Here,  $\phi$  is the nominal diameter of the wire or strand.

To avoid the transmission length in the clear span of a beam, **IS:1343 - 1980** recommends the following.

- 1) To have an overhang of a simply supported member beyond the support by a distance of at least  $\frac{1}{2} L_t$ .

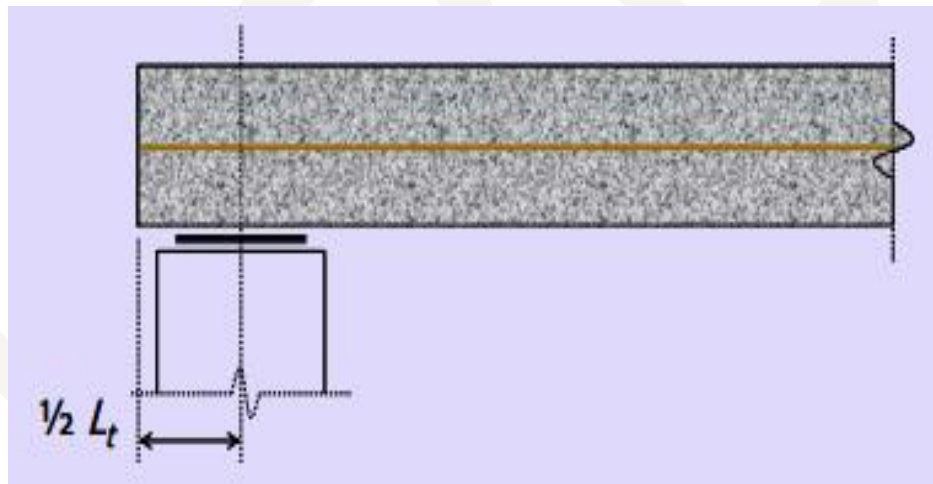

Figure 7-1.5 End of a simply supported member

- 2) If the ends have fixity, then the length of fixity should be at least  $L_t$ .

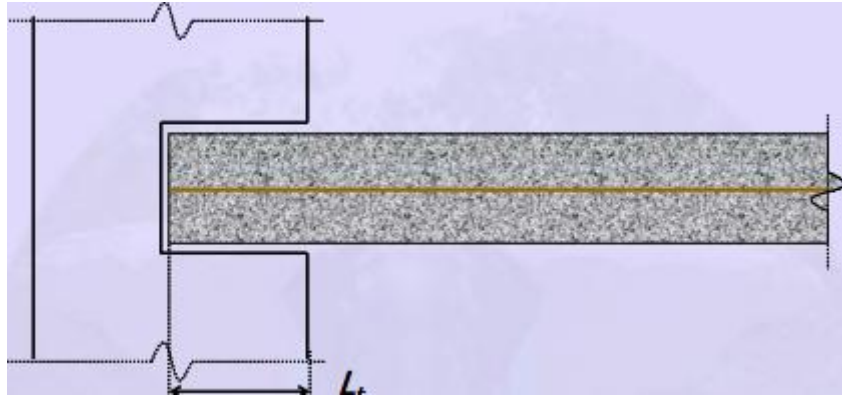

Figure 7-1.6 End of a member with fixity

### Development Length

The development length needs to be provided at the critical section, the location of maximum moment. The length is required to develop the ultimate flexural strength of the member. The development length is the minimum length over which the stress in tendon can increase from zero to the ultimate prestress ( $f_{pu}$ ). The development length is significant to achieve ultimate capacity.

If the bonding of one or more strands does not extend to the end of the member (debonded strand), the sections for checking development of ultimate strength may not be limited to the location of maximum moment.

The development length ( $L_d$ ) is the sum of the transmission length ( $L_t$ ) and the bond length ( $L_b$ ).

$$L_d = L_t + L_b$$

The bond length is the minimum length over which, the stress in the tendon can increase from the effective prestress ( $f_{pe}$ ) to the ultimate prestress ( $f_{pu}$ ) at the critical location.

The following figure shows the variation of prestress in the tendon over the length of a simply supported beam at ultimate capacity.

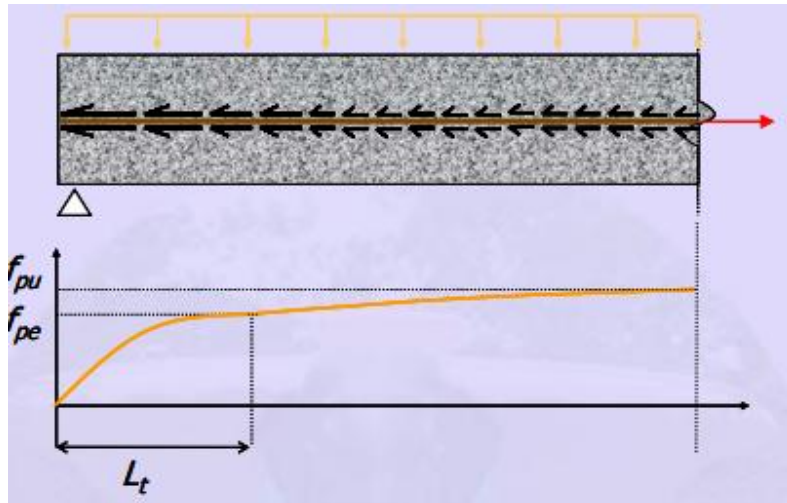

Figure 7-1.7 Variation of prestress in tendon at ultimate

The calculation of the bond length is based on an average design bond stress ( $\tau_{bd}$ ). A linear variation of the prestress in the tendon along the bond length is assumed. The following sketch shows a free body diagram of a tendon along the bond length.

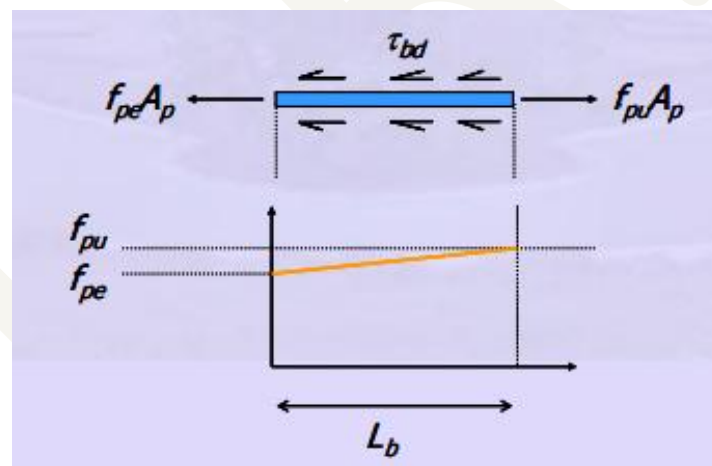

Figure 7-1.8 Assumed variation of prestress in tendon along the bond length

The bond length depends on the following factors. 1) Surface condition of the tendon

- 3) Size of tendon
- 4) Stress in tendon
- 5) Depth of concrete below tendon

From equilibrium of the forces in the above figure, the expression of the bond length is derived.

$$L_b = \frac{(f_{pu} - f_{pe}) \Phi}{4\tau_{bd}}$$

Here,  $\Phi$  is the nominal diameter of the tendon. The value of the design bond stress ( $\tau_{bd}$ ) can be obtained from IS:456 - 2000, Clause 26.2.1.1. The table is reproduced below.

Table 7-1.2 Design bond stress for plain bars

Grade of concrete	M30	M35	M40 and above
$\tau_{bd}$ (N/mm <sup>2</sup> )	1.5	1.7	1.9

**End Zone Reinforcement** The prestress and the Hoyer effect cause transverse tensile stress ( $\sigma_t$ ). This is largest during the transfer of prestress. The following sketch shows the theoretical variation of  $\sigma_t$ .

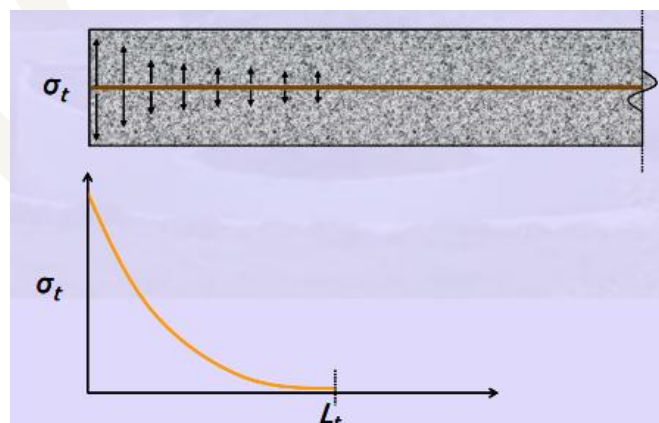

Figure 7-1.9 Transverse stress in the end zone of a pre-tensioned beam

To restrict the splitting of concrete, transverse reinforcement (in addition to the reinforcement for shear) needs to be provided at each end of a member along the transmission length. This reinforcement is known as end zone reinforcement. The generation of the transverse tensile stress can be explained by the free body diagram of the following zone below crack, for a beam with an eccentric tendon. Tension ( $T$ ), compression ( $C$ ) and shear ( $V$ ) are generated due to the moment acting on the horizontal plane at the level of the crack. The internal forces along the horizontal plane are shown in (a) of the following figure. The variation of moment (due to the couple of the normal forces) at horizontal plane along the depth is shown in (b).

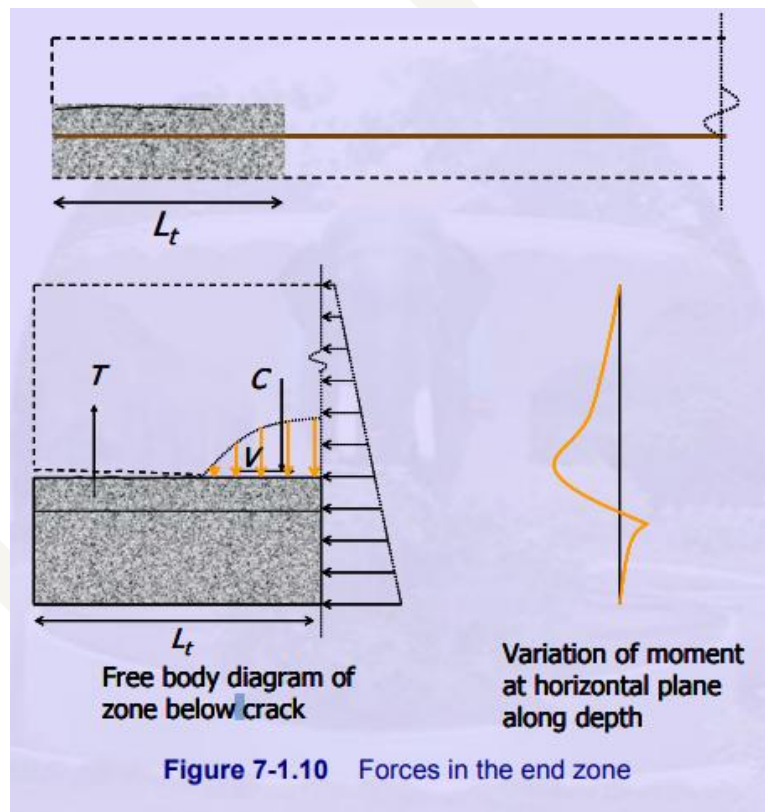

Figure 7-1.10 Forces in the end zone

### Example

Design the end zone reinforcement for the pre-tensioned beam shown in the following figure.

The sectional properties of the beam are as follows.

$$A = 46,400 \text{ mm}^2$$

$$I = 8.47 \times 10^8 \text{ mm}^4$$

$$Z = 4.23 \times 10^5 \text{ mm}^3$$

There are 8 prestressing wires of 5 mm diameter.

$$A_p = 8 \times 19.6 = 157 \text{ mm}^2$$

The initial prestressing is as follows.

$$f_{p0} = 1280 \text{ N/mm}^2.$$

Limit the stress in end zone reinforcement ( $f_s$ ) to  $140 \text{ N/mm}^2$

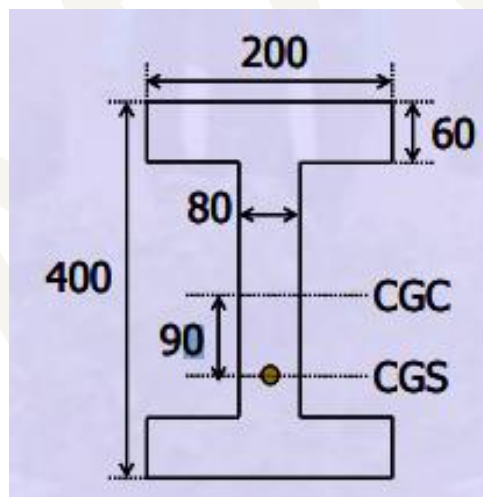

Cross-section at end

Solution:

- 1) Determination of stress block above CGC

Initial prestressing force

$$\begin{aligned} P_0 &= A_p \cdot f_{p0} \\ &= 157 \times 1280 \text{ N} \end{aligned}$$

$$= 201 \text{ kN}$$

Stress in concrete at top

$$f_t = -\frac{P_0}{A} + \frac{P_0 e}{Z}$$

$$= -\frac{201 \times 10^3}{46400} + \frac{201 \times 10^3 \times 90}{4.23 \times 10^5}$$

$$\approx 0 \text{ N/mm}^2$$

Stress at bottom:

$$f_b = -\frac{P_0}{A} - \frac{P_0 e}{Z}$$

$$= -\frac{201 \times 10^3}{46400} - \frac{201 \times 10^3 \times 90}{4.23 \times 10^5}$$

$$= -8.60 \text{ N/mm}^2$$

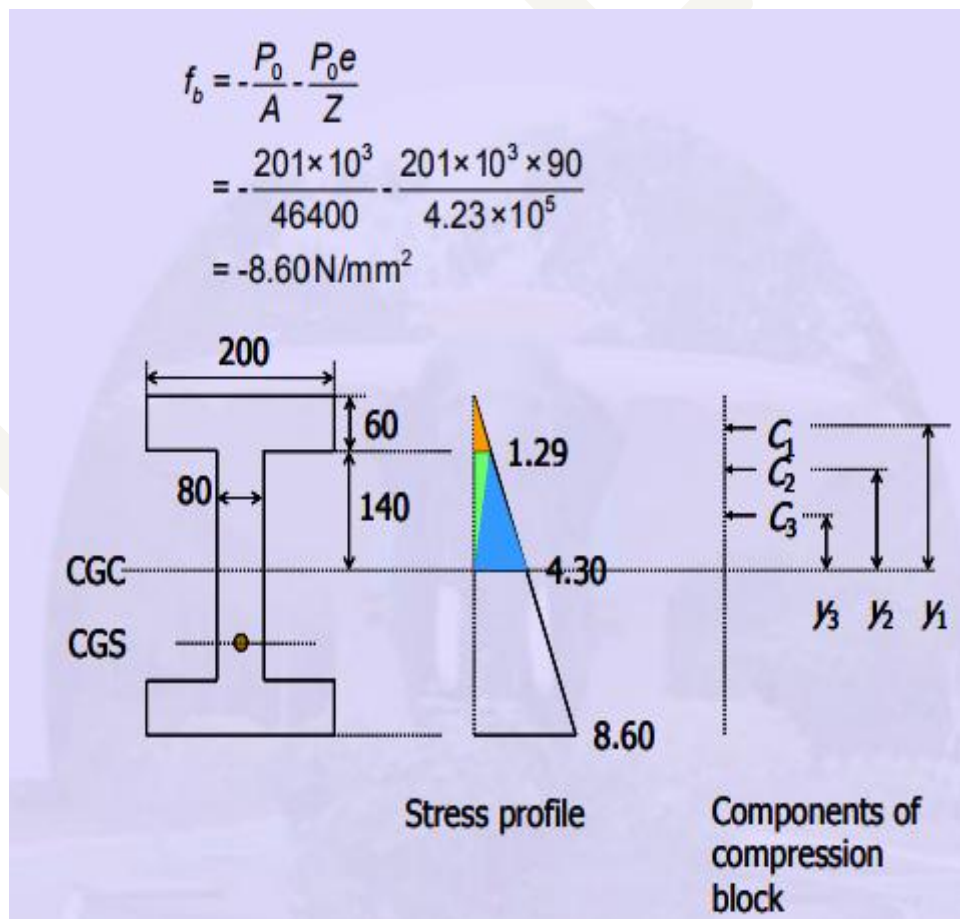

2) Determination of components of compression block

$$C1 = \frac{1}{2} \times 1.29 \times 200 \times 60 = 7.74 \text{ kN}$$

$$y1 = 140 + \frac{1}{3} \times 60 = 160 \text{ mm}$$

$$C2 = \frac{1}{2} \times 1.29 \times 140 \times 80 = 7.22 \text{ kN}$$

$$y2 = \frac{2}{3} \times 140 = 93.3 \text{ mm}$$

$$C3 = \frac{1}{2} \times 4.3 \times 140 \times 80 = 24.08 \text{ kN}$$

$$y3 = \frac{1}{3} \times 140 = 46.7 \text{ mm}$$

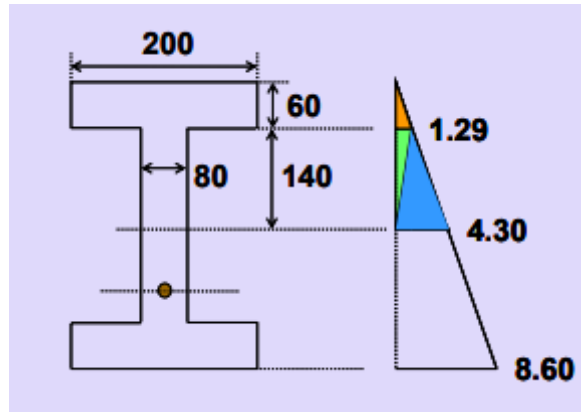

3) Determination of moment

$$M = \sum C_i \cdot y_i$$

$$= C1 \cdot y1 + C2 \cdot y2 + C3 \cdot y3$$

$$= (7.74 \times 160) + (7.22 \times 93.3) + (24.08 \times 46.7)$$

$$= 3036.6 \text{ kN-mm}$$

4) Determination of amount of end zone reinforcement

$$\begin{aligned} A_{st} &= \frac{2.5M}{f_s h} \\ &= \frac{2.5M}{140 \times 400} \\ &= \frac{2.5 \times 3036.6 \times 10^3}{140 \times 400} \\ &= 135.6 \text{ mm}^2 \end{aligned}$$



With 6 mm diameter bars, required number of 2 legged closed stirrups

$$= 135.6 / (2 \times 28.3) \Rightarrow 3.$$

For plain wires, transmission length

$$L_t = 100 \Phi$$

$$= 500 \text{ mm.}$$

Provide 2 stirrups within distance 250 mm ( $L_t/2$ ) from the end. The third stirrup is in the next 250 mm.

Designed end zone reinforcement

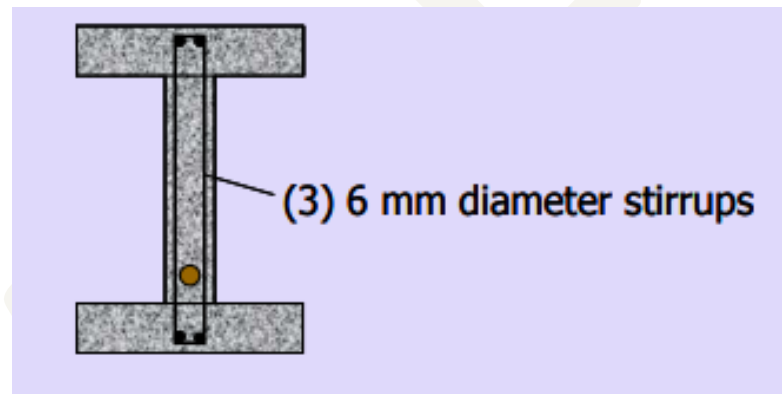

## UNIT-V

### COMPOSITE BEAMS

#### Introduction

A composite section in context of prestressed concrete members refers to a section with a precast member and cast-in-place (CIP) concrete. There can be several types of innovative composite sections. A few types are sketched below.

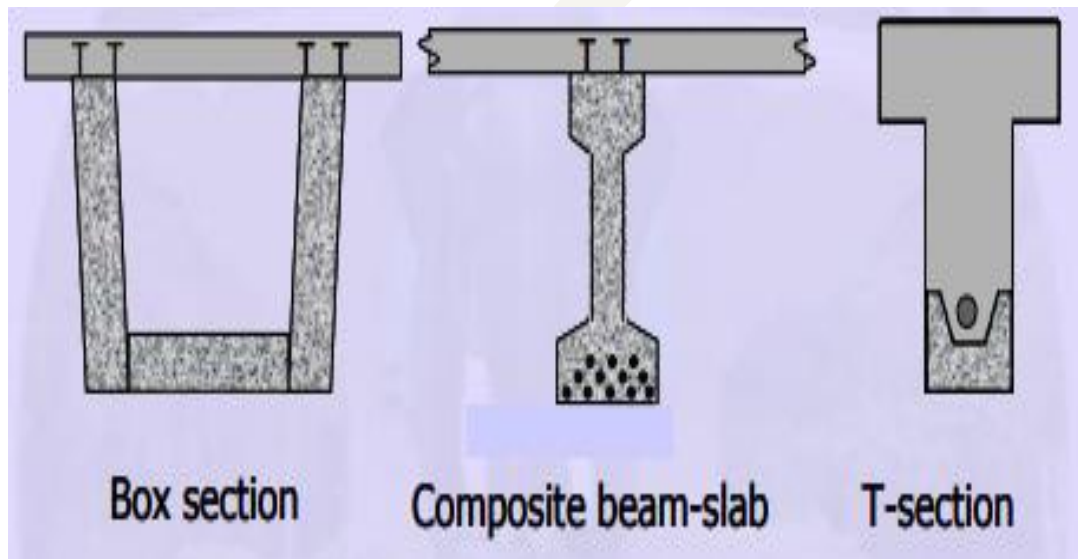

Examples of composite sections

Composite construction implies the use, in a single structure acting as a unit, of different structural element made with similar or different structural materials. • In a composite member where only concrete is used as a material, the concrete is placed in at least two 2 In a composite member where only concrete is used as a material, the concrete is placed in at least two separate stages generally leading to two different unit weights and/or properties. • This is the case of composites made with precast reinforced or prestressed concrete element combined with a concrete element cast in situ at a different time. • Typical composite cross-sections are as shown in the next slide

The following photos show the reinforcement for the slab of a box girder bridge deck with precast webs and bottom flange. The slab of the top flange is cast on a stay-in formwork.

The reinforcement of the slab is required for the transverse bending of the slab. The reinforcement at the top of the web is required for the horizontal shear transfer.

The advantages of composite construction are as follows.

- Total construction time is substantially reduced when precast concrete elements are used.
- Pre-tensioning in plant is more cost-effective than post-tensioning on site. Because the precast prestressed concrete element is factory-produced and contains the bulk of reinforcement, rigorous quality control and higher mechanical properties can be achieved at relatively low cost. The cast in situ concrete slab does not need to have high mechanical properties and thus is suitable to field conditions.
- The precast prestressed concrete units are erected first and can be used to support the formwork needed for the cast in situ slab without additional scaffolding (or shoring) 5
- In addition to its contribution to the strength and stiffness of the composite member, the cast in situ slab provides an effective means to distribute loads in the lateral direction.
- The cast in situ slab can be poured continuously over the supports of precast units placed in series, thus providing continuity to a simple span system
- Savings in form work
- Fast-track construction
- Easy to connect the members and achieve continuity

The prestressing of composite sections can be done in stages. The precast member can be first pre-tensioned or post-tensioned at the casting site. After the cast-in-place (cast-in-situ) concrete achieves strength, the section is further post-tensioned. The grades of concrete for

the precast member and the cast-in-place portion may be different. In such a case, a transformed section is used to analyse the composite section.

**Analysis of Composite Sections :**

The analysis of a composite section depends upon the type of composite section, the stages of prestressing, the type of construction and the loads. The type of construction refers to whether the precast member is propped or unpropped during the casting of the CIP portion. If the precast member is supported by props along its length during the casting, it is considered to be propped. Else, if the precast member is supported only at the ends during the casting, it is considered to be unpropped.

The following diagrams are for a composite section with precast web and cast-in-place flange. The web is prestressed before the flange is cast. At transfer and after casting of the flange (before the section behaves like a composite section), the following are the stress profiles for the precast web.

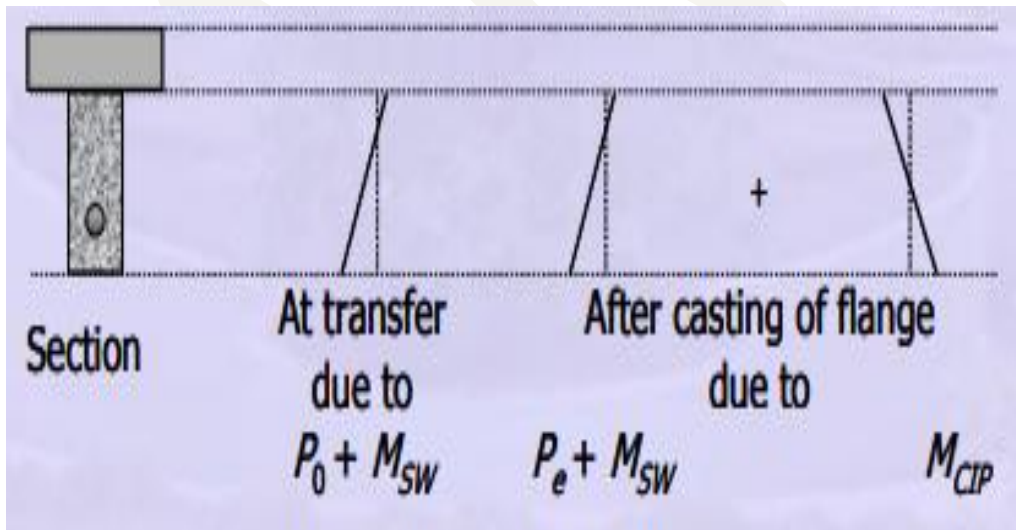

Figure 9-1.3 Stress profiles for the precast web

Here,  $P_0$  = Prestress at transfer after short term losses

$P_e$  = Effective prestress during casting of flange after long term losses

$M_{SW}$  = Moment due to self weight of the precast web

$M_{CIP}$  = Moment due to weight of the CIP flange.

At transfer, the loads acting on the precast web are  $P_0$  and  $M_{SW}$ . By the time the flange is cast, the prestress reduces to  $P_e$  due to long term losses. In addition to  $P_e$  and  $M_{SW}$ , the web also carries  $M_{CIP}$ . The width of the flange is calculated based on the concept of effective flange width as per Clause 23.1.2, IS:456 - 2000.

At service (after the section behaves like a composite section) the following are the stress profiles for the full depth of the composite section.

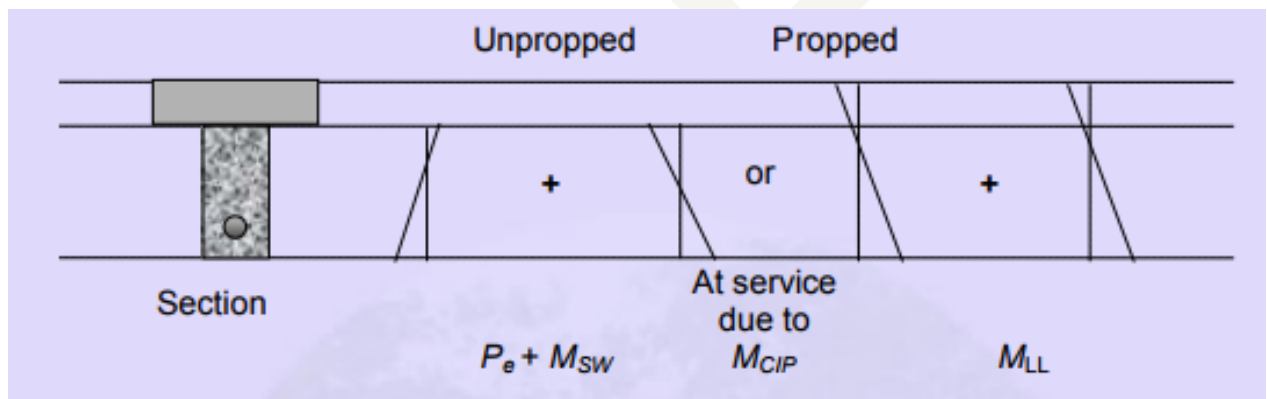

Figure 9-1.4 Stress profiles for the composite section

Here,  $M_{LL}$  is the moment due to live load. If the precast web is unpropped during casting of the flange, the section does not behave like a composite section to carry the prestress and self weight. Hence, the stress profile due to  $P_e + M_{SW} + M_{CIP}$  is terminated at the top of the precast web. If the precast web is propped during casting and hardening of the flange, the section behaves like a composite section to carry the prestress and self weight after the props are removed. The stress profile is extended up to the top of the flange. When the member is placed in service, the full section carries  $M_{LL}$ .

From the analyses at transfer and under service loads, the stresses at the extreme fibres of the section for the various stages of loading are evaluated. These stresses are compared with the respective allowable stresses.

Stress in precast web at transfer

$$f = -\frac{P_0}{A} \pm \frac{P_0 e c}{I} \pm \frac{M_{SW} c}{I}$$

Stress in precast web after casting of flange

$$f = -\frac{P_e}{A} \pm \frac{P_e e c}{I} \pm \frac{(M_{SW} + M_{CIP}) c}{I}$$

Stress in precast web at service

(a) For unpropped construction

$$f = -\frac{P_e}{A} \pm \frac{P_e e c}{I} \pm \frac{(M_{SW} + M_{CIP}) c}{I} \pm \frac{M_{LL} c'}{I'}$$

(b) For propped construction

$$f = -\frac{P_e}{A} \pm \frac{P_e e c}{I} \pm \frac{M_{SW} c}{I} \pm \frac{(M_{CIP} + M_{LL}) c'}{I'}$$

Here,

A = area of the precast web

c = distance of edge from CGC of precast web

$c'$  = distance of edge from CGC of composite section

$e$  = eccentricity of CGS

$I$  = moment of inertia of the precast web

$I'$  = moment of inertia of the composite section.

From the analysis for ultimate strength, the ultimate moment capacity is calculated. This is compared with the demand under factored loads.

The analysis at ultimate is simplified by the following assumptions.

- 1) The small strain discontinuity at the interface of the precast and CIP portions is ignored.
- 2) The stress discontinuity at the interface is also ignored.
- 3) If the CIP portion is of low grade concrete, the weaker CIP concrete is used for calculating the stress block. The strain and stress diagrams and the force couples at ultimate are shown below.

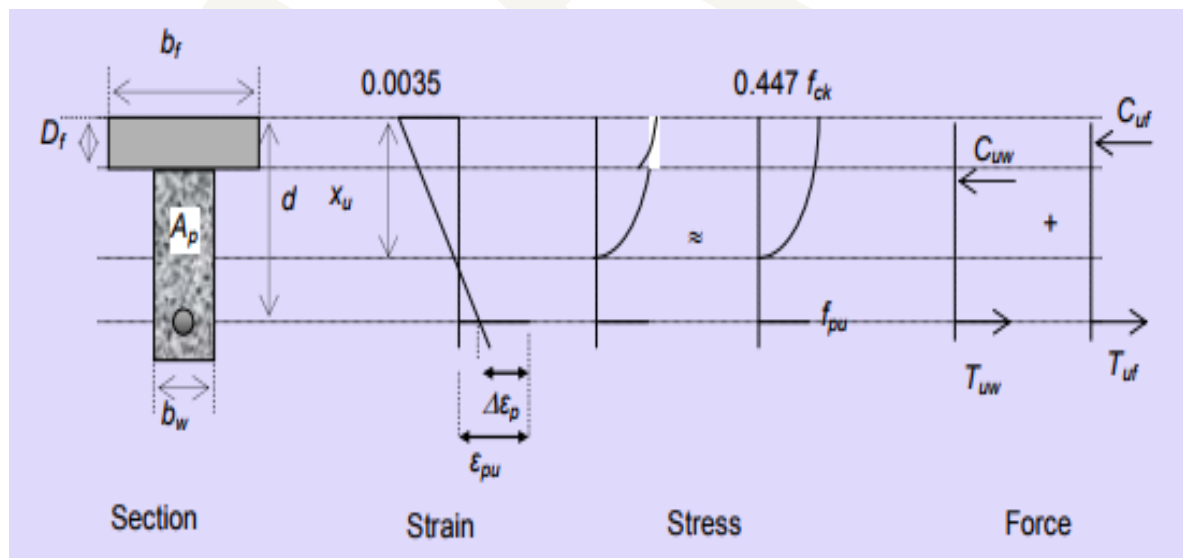

Figure 9-1.5 Sketches for analysis at ultimate

The variables in the above figure are explained.

$b_f$  = breadth of the flange

$b_w$  = breadth of the web

$D_f$  = depth of the flange

$d$  = depth of the centroid of prestressing steel (CGS)

$A_p$  = area of the prestressing steel

$\Delta_{ep}$  = strain difference for the prestressing steel

$x_u$  = depth of the neutral axis at ultimate

$\epsilon_{pu}$  = strain in prestressing steel at the level of CGS at ultimate

$f_{pu}$  = stress in prestressing steel at ultimate

$f_{ck}$  = characteristic compressive strength of the weaker concrete

$C_{uw}$  = resultant compression in the web (includes portion of flange above precast web)

$C_{uf}$  = resultant compression in the outstanding portion of flange

$T_{uw}$  = portion of tension in steel balancing  $C_{uw}$ .

$T_{uf}$  = portion of tension balancing  $C_{uf}$ .

The expressions of the forces are as follows.

$$C_{uw} = 0.36f_{ck} x_u w b_w$$

$$C_{uf} = 0.447f_{ck} (b_f - b_w) D_f$$

$$T_{uw} = A_{pw} p_{uf}$$

$$T_{uf} = A_{pf} p_u$$

The symbols for the areas of steel are as follows.

$A_{pf}$  = part of  $A_p$  that balances compression in the outstanding flanges

$A_{pw}$  = part of  $A_p$  that balances compression in the web

The equilibrium equations are given below. These equations are explained in Section 3.5,

Analysis of Members under Flexure (Part IV). The ultimate moment capacity ( $M_u$ ) is

calculated from the second equation.



$$\sum F = 0$$

$$\Rightarrow (A_{pw} + A_{pf})f_{pu} = 0.36 f_{ck} x_u b_w + 0.447 f_{ck} (b_f - b_w) D_f$$

$$M_{uR} = A_{pw} f_{pu} (d - 0.42 x_u) + A_{pf} f_{pu} (d - 0.5 D_f)$$

### Design of Composite Sections :

The design is based on satisfying the allowable stresses under service loads and at transfer. The section is then analysed for ultimate loads to satisfy the limit state of collapse. The member is also checked to satisfy the criteria of limit states of serviceability, such as deflection and crack width (for Type 3 members only). Before the calculation of the initial prestressing force (P0) and the eccentricity of the CGS (e) at the critical section, the type of composite section and the stages of prestressing need to be decided. Subsequently, a trial and error procedure is adopted for the design.

The following steps explain the design of a composite section with precast web and cast-in-place flange. The precast web is prestressed before the casting of the flange. The member is considered to be Type 1 member.

#### Step 1. Compute Eccentricity, e

With a trial section of the web, the CGS can be located at the maximum eccentricity (e<sub>max</sub>). The maximum eccentricity is calculated based on zero stress at the top of the precast web. This gives an economical solution. The following stress profile is used to determine e<sub>max</sub>.

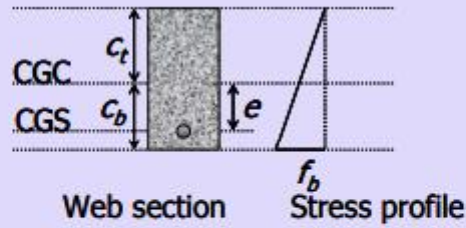

**Figure 9-1.6** Stress profile for maximum eccentricity of CGS

$$e_{max} = k_b + \frac{M_{sw}}{P_0}$$

Here, CGC = Centroid of the precast web

$k_b$  = Distance of the bottom kern of the precast web from CGC

$M_{sw}$  = Moment due to self weight of the precast web.

$P_0$  = A trial prestressing force at transfer.

### Step 2.

Compute equivalent moment for the precast web. A moment acting on the composite section is transformed to an equivalent moment for the precast web. This is done to compute the stresses in the precast web in terms of the properties of the precast web itself and not of the composite section.

For a moment  $M_c$  which acts after the section behaves like a composite section, the stresses in the extreme fibres of the precast web are determined from the following stress profile.

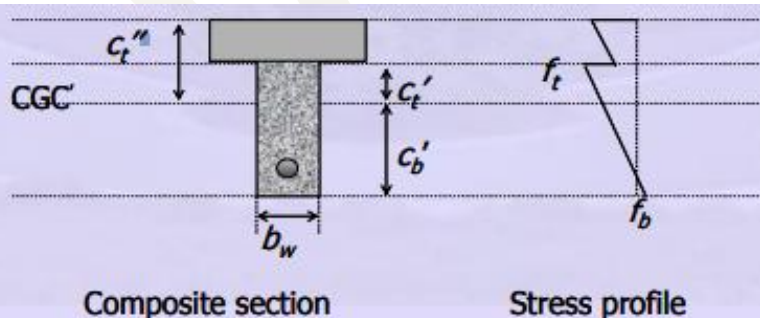

**Figure 9-1.7** Stress profile for the composite section

$$f_t = \frac{M_c c_t'}{I'}$$

$$f_b = \frac{M_c c_b'}{I'}$$

Here,

CGC' = centroid of the composite section

$c_t'$  = Distance of the top of the precast web from the CGC'

$c_t''$  = Distance of the top of the composite section from the CGC'.

$c_b'$  = Distance of the bottom of the precast web (or composite section) from the CGC'

$I'$  = moment of inertia for the composite section.

The following quantities are defined as the ratios of the properties of the precast web and composite section.

$$m_t = \frac{I/c_t}{I'/c_t'}$$
$$m_b = \frac{I/c_b}{I'/c_b'}$$

Then the stresses in the extreme fibres of the precast web can be expressed in terms of  $m_t$  and  $m_b$  as follows.

$$f_t = \frac{m_t M_c c_t}{I} = \frac{m_t M_c}{A k_b}$$
$$f_b = \frac{m_b M_c c_b}{I} = \frac{m_b M_c}{A k_t}$$

Here,  $A$  = Area of the precast web

$k_b$  = Distance of the bottom kern of the precast web from CGC

$k_t$  = Distance of the top kern of the precast web from CGC

The quantities  $m_t M_c$  and  $m_b M_c$  are the equivalent moments. Thus, the stresses in the precast web due to  $M_c$  are expressed in terms of the properties of the precast web itself.

**Step 3.** Compute  $P_e$

Let  $M_p$  be the moment acting on the precast web prior to the section behaving like a composite section. After  $M_c$  is applied on the composite section, the total moment for the precast web is  $M_p + m_b M_c$ .

The stress at the bottom for Type 1 member due to service loads is zero.

Therefore,

$$-\frac{P_e}{A} - \frac{P_e e}{A k_t} + \frac{M_p + m_b M_c}{A k_t} = 0$$

$$\text{or, } P_e = \frac{(M_p + m_b M_c)}{e + k_t}$$

Note that the prestressing force is acting only on the precast web and hence,  $e$  is the eccentricity of the CGS from the CGC of the precast web.

**Step 4.** Estimate  $P_0$  as follows.

- a) 90% of the initial applied prestress ( $P_i$ ) for pre-tensioned members.
- b) Equal to  $P_i$  for post-tensioned members.

The value of  $P_i$  is estimated as follows.

$$P_i = A_p (0.8 f_{pk})$$

$$A_p = P_e / 0.7 f_{pk}$$

Revise  $e$ , the location of CGS, as given in Step 1 based on the new value of  $P_0$ .

$$e_{max} = k_b + \frac{M_{sw}}{P_0}$$

**Step 5.** Check for the compressive stresses in the precast web.

At transfer, the stress at the bottom is given as follows.

$$f_b = -\frac{P_0}{A} - \frac{P_0 e}{Ak_t} + \frac{M_{sw}}{Ak_t}$$

The stress  $f_b$  should be limited to  $f_{cc,all}$ , where  $f_{cc,all}$  is the allowable compressive stress in concrete at transfer (available from Figure 8 of IS:1343 - 1980).

At service,

$$f_t = -\frac{P_e}{A} - \frac{P_e e}{Ak_b} + \frac{(M_p + m_t M_c)}{Ak_b}$$

The stress  $f_t$  should be limited to  $f_{cc,all}$ , where  $f_{cc,all}$  is the allowable compressive stress in concrete under service loads (available from Figure 7 of IS:1343-1980).

If the stress conditions are not satisfied, increase A.

**Step 6.** Check for the compressive stress in the CIP flange.

$$f_t' = \frac{M_c C_t''}{I'}$$

The stress  $f_t'$  / should be limited to  $f_{cc,all}$ , where  $f_{cc,all}$  is the allowable compressive stress in concrete under service loads.

## Deflection

### Introduction

- The effect of deflection in a structure varies according to the use of the structure.
- Excessive deflections may lead to sagging floors, to roof that do not drain properly, to damage partitions and finishes, to the creation of pools of water on road surface of bridges, and to other associated troubles

The total deflection is a resultant of the upward deflection due to prestressing force and deflection due to prestressing force and downward deflection due to the gravity loads.

Only the flexural deformation is considered and any shear deformation is neglected in the calculation of deflection.

### Deflection of Prestressed concrete Beam:

1. Fully prestressed concrete members (class 1 and class 2) remain crack-free under service load
2. Can be assumed linearly elastic
3. Two types of deflection
  - Short -term or instantaneous
  - Long-term

4. Short-term deflection occurs immediately upon the application of a load (caused by elastic deformation of the concrete in response to loading)
5. The short term deflection at transfer is due to the initial prestressing force and self initial initial prestressing prestressing force and self-weight without weight without the effect of creep and shrinkage of concrete.
6. Long-term deflection takes into account the long-term shrinkage and creep movements (time-dependent)
7. The long term deflection under service loads is due to the effective prestressing force and the total gravity loads.
8. The deflection of a flexural member is calculated to satisfy a limit state of serviceability
9. Due to external loads
10. Due to prestressed force
11. Can use various methods to calculate deflections
  - Double Integration Method (McCauley)
  - Moment Area Method
  - Conjugate Beam Method
  - Principle of Virtual Load

#### **Deflection due to Prestressing Force**

- The prestressing force causes a deflection only if the CGS is eccentric to the CGC if the CGS is eccentric eccentric to the CGC.
- Deflection due to prestressing force is calculated by the load by the load-balancing method. balancing method.

**Example:**

Determine the midspan deflection of the beam shown below:

- (i) at transfer with an inertial prestress force of 6800kN;
- (ii) under an imposed load of 30 kN/m when the prestress force has been reduced to 4500 kN. Take self weight of beam = 11.26 kN/m;  $I = 0.006396\text{m}^4$ ;  $E = 28 \times 10^6 \text{ kN/m}^2$

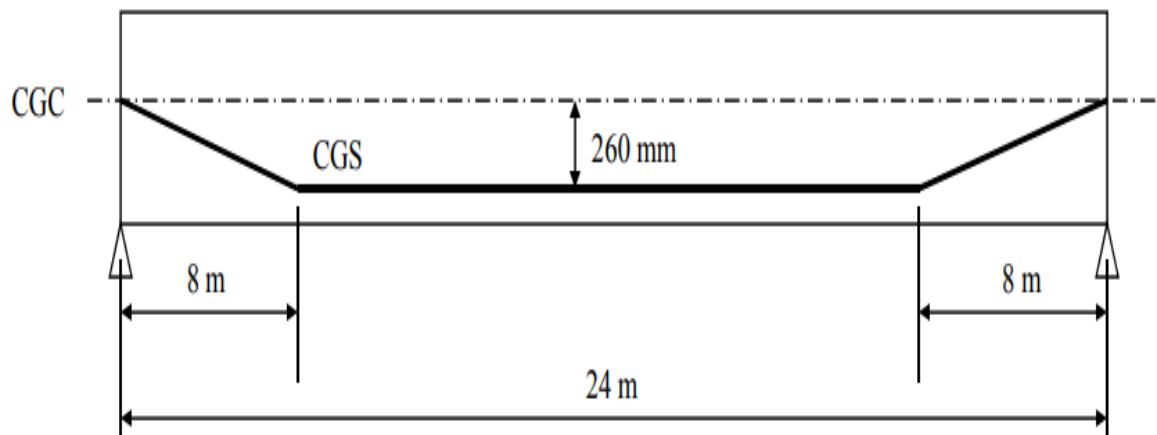

**Solution:**

Beam self weight = 11.26 kN/m

Total service load = 11.26 + 30  
= 41.26 kN/m

At Transfer, deflection(camber), due to prestress force

$$\delta = - 6800 \times 242 [0.26 - 4 \times 0.26 \times 82 / (3 \times 242)] / (8 \times 28 \times 10^6 \times 0.06396) \text{ 9}$$
$$\delta = - 6800 \times 242 [0.26 - 4 \times 0.26 \times 82 / (3 \times 242)] / (8 \times 28 \times 10^6 \times 0.06396)$$
$$= - 0.0605 \text{ m } \uparrow$$

At Transfer, deflection due to vertical load,



$$\delta = 5 \times 11.26 \times 244 / (384 \times 28 \times 10^6 \times 0.06396)$$

$$= 0.0272 \text{ m} \downarrow$$

$$\delta_{st} = -0.0605 + 0.0272$$

$$= -0.0333 \text{ m} \uparrow$$

$$< \text{span}/250 = 0.096\text{m}$$

At Service, deflection(camber), due to prestress force

$$\delta = - 4500 \times 24^2 [0.26 - 4 \times 0.26 \times 8^2 / (3 \times 24^2)] / (8 \times 28 \times 10^6 \times 0.06396)$$

$$= - 0.0401 \text{ m} \uparrow$$

At Service, deflection due to vertical load, Solution 10

$$\delta = 5 \times 41.26 \times 24^4 / (384 \times 28 \times 10^6 \times 0.06396)$$

$$= 0.0995 \text{ m} \downarrow$$

$$\delta_{st} = -0.0401 + 0.0995 = 0.0594 \text{ m} \downarrow$$

$$< \text{span}/250 = 0.096\text{m}$$

### Long-term Deflection:

1. Effect of shrinkage usually small and are often ignored
2. Effect of creep may be estimated using a method given in BS8110 whereby an effective modulus of elasticity,  $E_{c \text{ eff}}$  is given by

$$E_{c \text{ eff}} = E_{c,t} / (1 + \phi)$$

$$E_{c,t} = E_{c,28} [0.4 + 0.6 \times f_{cu,t} / f_{cu,28}]$$

$$E_{c,28} = 20 + 0.2 f_{cu,28}$$

$$\text{Total long term deflection} = \delta_{lt,p1} + \delta_{st,tl} - \delta_{st,pl}$$

### Example:

Determine the long-term deflection of the beam, if two-thirds of the total service load is permanent. Assume  $f_{cu,28} = 40 \text{ N/mm}^2$ ;  $b = 930 \text{ mm}$ ;  $h = 1035 \text{ mm}$ ;

$$A = 47.82 \times 104 \text{mm}^2$$

**Solution:**

Long-term deflection under permanent load

Due to prestress force:

$$\delta = -4500 \times 242 [0.26 - 4 \times 0.26 \times 82 / (3 \times 242)] / (8 \times 16.9 \times 106 \times 0.06396)$$

$$= -0.0663 \text{ m} \uparrow$$

Due to vertical load (Service Load\*2/3):

$$\delta = 5 \times (2/3) \times 41.26 \times 244 / (384 \times 16.9 \times 106 \times 0.06396)$$

$$= 0.1100 \text{ m} \downarrow$$

$$\delta_{lt,pl} = -0.0663 + 0.1100$$

$$= 0.0437 \text{ m} \downarrow$$

The total long-term deflection = 0.0437+0.0595-0.0263

$$= 0.0769 \text{ m} \downarrow$$

$$< \text{span}/250 = 0.096 \text{m}$$